

51.2V Rack Mode Lithium Energy Storage Battery











USER INSTRUCTION

This manual introduces 51.2V Rack Mode Lithium Energy Storage Battery. Please read this manual before you install the battery and follow the instruction carefully during installation process. Please contact immediately for advice and clarification if you have any question.

Contents

1. Symbol Description	4
2. Safety Precautions	5
2.1 Before Connecting	5
2.2 In Using	6
3.Introduction	6
4.Product Function Description	7
4.1 Dimensions	7
4.2 Product Specifications	8
4.3 Equipment interface instruction	9
4.4 Parallel Connection	9
4.5 Dial Code Switch Settings (parallel connection needed)	12
4.6 Communication Function	12
1)RS232 communication	12
2)RS485-1 / CAN main communication	13
3)RS485-2 communication for parallel connection	13
4.7 LED Indication Function	14
4.8 LCD introduction	15
4.8.1 Reference physical image	15
4.8.2 Display rendering	16
4.8.3 Main Menu Page	16
4.8.4 Page definition not displayed	16
4.8.5 Key Description	18
4.8.6 Screen selection protocol:	18
4.8.7 Hibernate/shut down	19
4.9 Sleep Mode	19
4.10 Awake Mode	19
5 Installation and operation	19
5.1 Installation Location	19
5.2 Installation Direction	20
5.3 Installation Steps	20
5.4 Assembly steps	21
6 · Electrical Specification	22
7. BMS	23
7.1 BMS System Schematic Diagram	23

1. Symbol Description

	Do not place near open fire or flammable materials.
	A potential hazard exists when the equipment is working. Wear personal protective equipment during operation.
	Warning electric shock. Power off the equipment before any operation.
	Grounding: indicate PE cable connection position.
	Do not place in areas accessible to children.
	Keep the battery away from open fire or ignition sources.
	Read the product and operation manual before operating the battery system.
	Label for Waste Electrical and Electronic Equipment (WEEE) Directive (2012/19/EU).
	The certificate label for CE.
	Recycle label.

2. Safety Precautions



Alert

- 1) It is important and necessary to read the user manual carefully (and attachment) before installing or using battery. Failure to do so or to follow any instruction or warning in this document can result in electrical shock, serious injury, and death, or damage battery, potentially rendering it unusable.
- 2) When battery is stored for a long time, it is required to charge once every 6 months, and the SOC should be no less than 50%.
- 3) After battery module cannot be discharged, it needs to be recharged within 12h.
- 4) Do not connect power terminal reversely.
- 5) All power supplies must be disconnected during maintenance.
- 6) Please contact the supplier within 24 hours if there is something abnormal.
- 7) Do not use any liquid to clean the battery.
- 8) Do not expose battery to flammable or irritating chemicals or vapor.
- 9) Do not paint any part of battery, including any internal or external components.
- 10) Do not connect battery with PV solar wiring directly.
- 11) Do not install or use this product beyond provisions of the manual.
- 12) Direct or indirect damages caused by the above reasons are not covered by warranty claim.



Warning

2.1 Before Connecting

- 1) Please check the external packaging condition before unpacking. If it is damaged, contact corresponding local retailer.
- 2) After unpacking, please check the products and spare parts according to spare parts list. If the product is damaged or missing, please contact your local retailer.
- 3) Connect to specified matching inverter.
- 4) Before installation, be sure to cut off the grid power and make sure battery switch is on OFF mode.
- 5) It is prohibited to connect the battery and AC power directly.
- 6) All electrical wiring must be connected in accordance with local regulations.
- 7) Please ensure that electrical performance of battery system is compatible with the equipment.
- 8) The installation onsite shall be equipped with fire-fighting facilities that meet relevant requirements, such as fire sand, dry powder fire extinguisher, etc.

2.2 In Using

- 1) If battery system needs to be moved or repaired, power must be cut off and battery is completely shut down. It is prohibited to connect battery with different types of battery.
- 2) Do not connect battery to faulty inverter.
- 3) In case of fire, only dry powder fire extinguisher can be used, liquid fire extinguishers are prohibited.
- 4) Except for personnel from Company or other authorized personnel, batteries shall not be opened, repaired or disassembled. The company shall not bear any liability or responsibility caused by violation of any safety operation or design standard, production standard, equipment safety standards or any other standards or requirements.

3. Introduction

This rack mode LifePo4 lithium battery belongs to one of the series of household energy storage products that are independently designed and developed. It has long cycle life, high safety standard BMS software protection and strong housing, exquisite looks, and easy installation, etc. It is widely used in energy storage system with off-grid inverters, on-off grid inverters and hybrid inverters.

4.Product Function Description

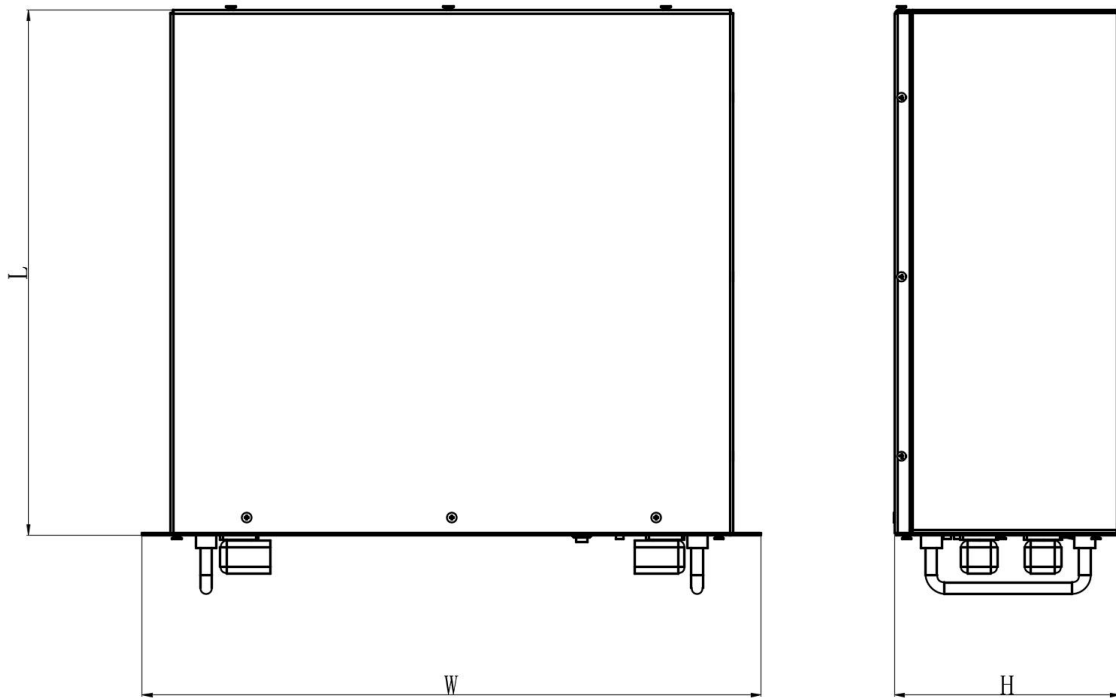

4.1 Dimensions

Figure 4-1

product model			
Specification	Length (L)	Width(W)	High (H)
51.2V100Ah	425mm	484mm	176.5mm
51.2V200Ah	773mm	560mm	165mm
51.2V280Ah	750mm	484mm	240mm

4.2 Product Specifications

Items		Condition	Specification		
Nominal Capacity		Standard charge/discharge	100.0Ah	200.0Ah	280.0Ah
Nominal Voltage		Average	51.2V	51.2V	51.2V
Standard Charging Refer to 6.1		Constant current Constant voltage End current(Cut off)	50A 57.6V 1A	50A 57.6V 1A	100A 57.6V 1A
Charging Voltage		/	57.6V	57.6V	57.6V
Max. Continuous Charge Current		25±3℃	100.0A	100.0A	200.0A
Standard Discharging Refer to 6.2		Constant current End voltage(Cut off)	50.0A 43.2V	100.0A 43.2V	140.0A 43.2V
Max Continuous Discharge Current		25±3℃	100.0A	100.0A	200.0A
Nominal Energy		25±3℃	5.12kWh	10.24kWh	14.336kWh
Available Energy		25±3℃	4.6kWh	9.2kWh	12.9kWh
Operating Temperature	Charge	/	0℃~ 55℃		
	Discharge	/	-30℃~ 55℃		
Storage Temperature		/	-20℃~ 55℃		-30℃~ 60℃
Weight		/	~41kg	~85kg	~106kg

4.3 Equipment interface instruction

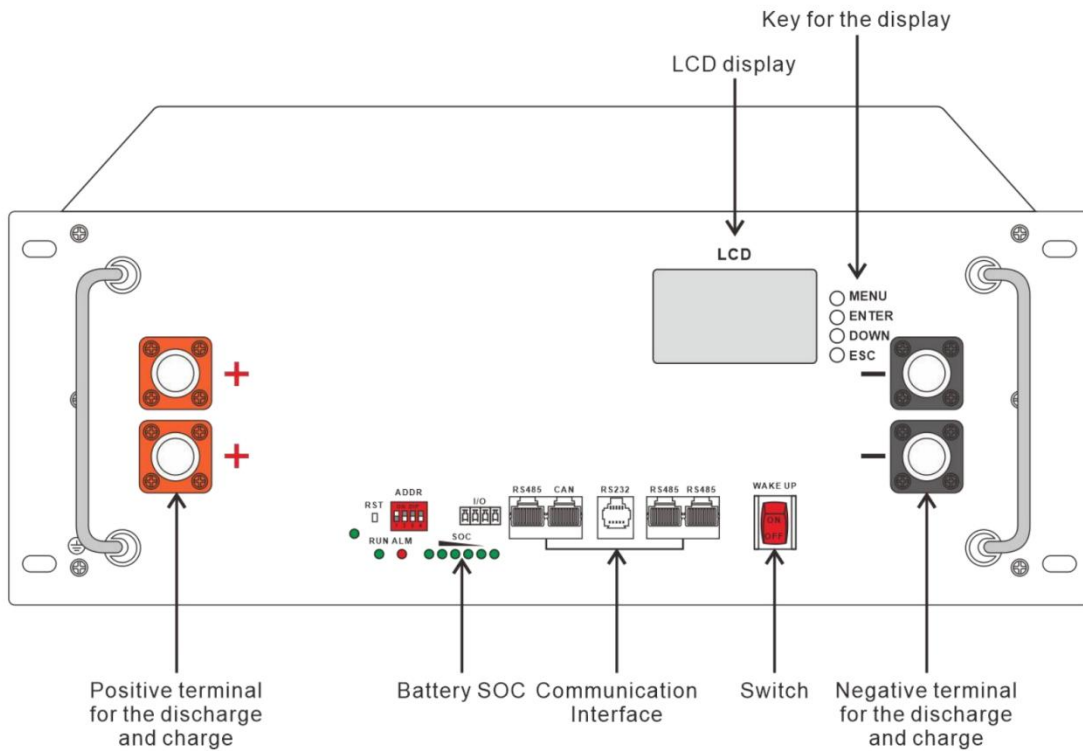
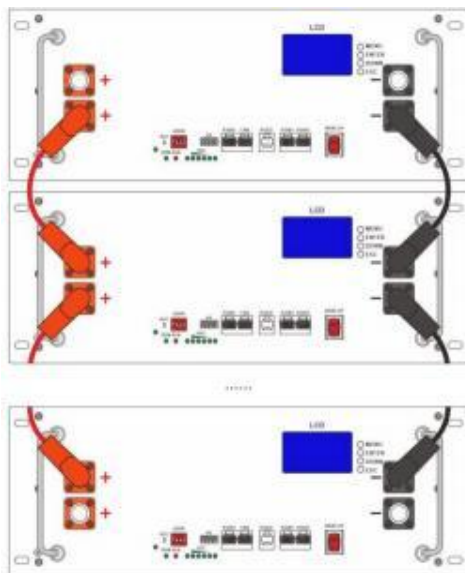

Figure 4-2

4.4 Parallel Connection

When Connect the batteries in parallel, connect the positive terminal and positive terminal (red colour) in parallel, and the negative terminal and negative terminal (black colour) in parallel, the max parallel quantity is 15pcs, as shown in the figure below:



15pcs max in parallel			
Model	Capacity	Max parallel	Max Capacity
51.2V 100Ah	5.12kWh	15pcs	51.2V1500Ah 76.8kWh
51.2V 200Ah	10.24kWh	15pcs	51.2V3000Ah 153.6kWh
51.2V 280Ah	14.34kWh	15pcs	51.2V4200Ah 215kWh

Solar System Structure

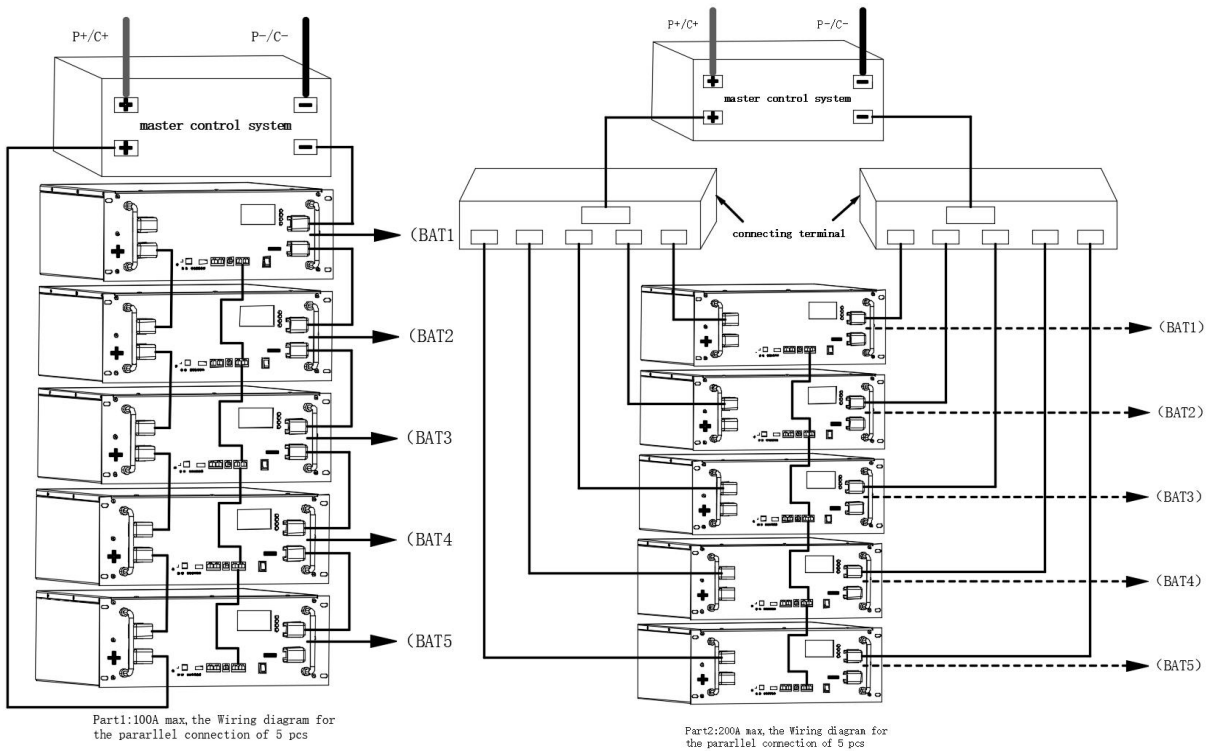
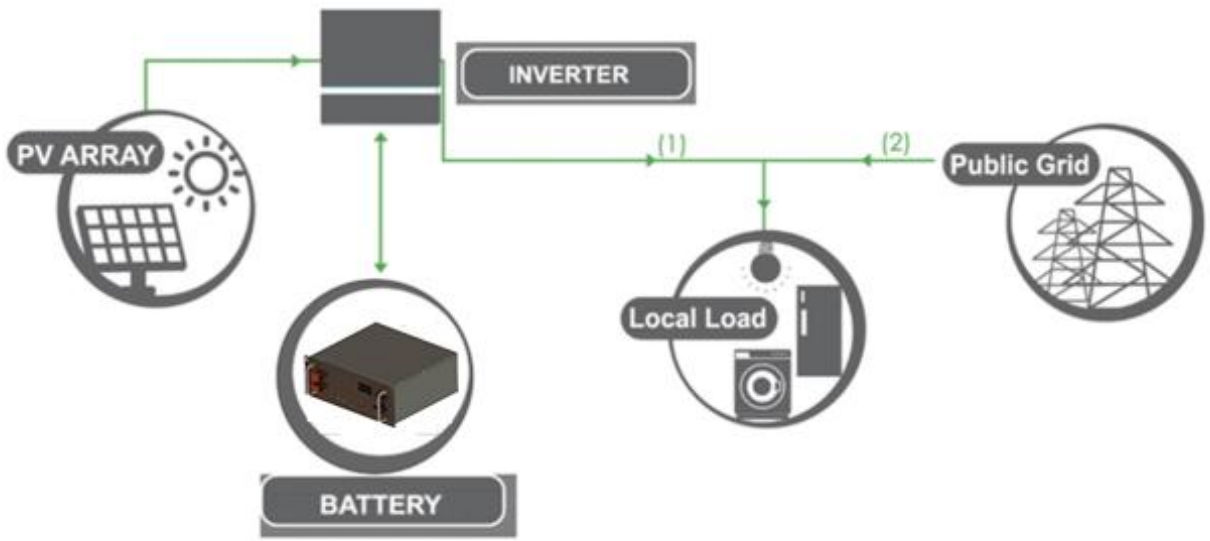

Part1:100A max, the Wiring diagram for the parallel connection of 5 pcs

Part2:200A max, the Wiring diagram for the parallel connection of 5 pcs

The parallel machine has dual RS485 interfaces. The first battery that communicates with the inverter serves as the main unit, and the 485-2 of the main unit is connected to the 485-1 of the next slave unit. The communication interfaces of each battery are connected in this staggered order, so that the main battery can read the information of each battery.

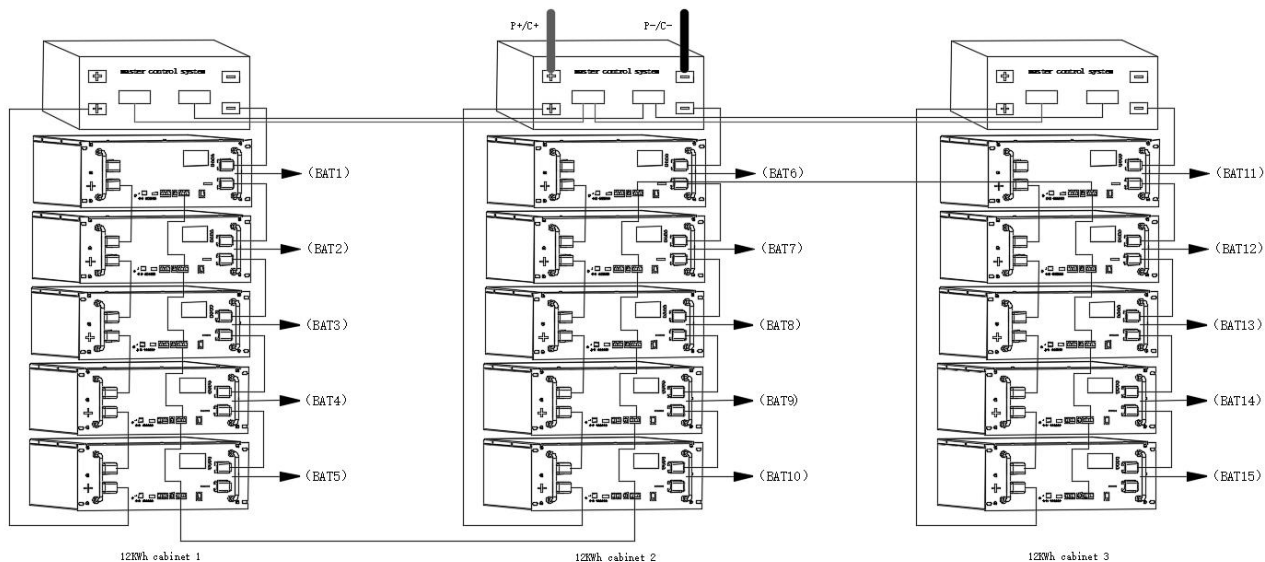
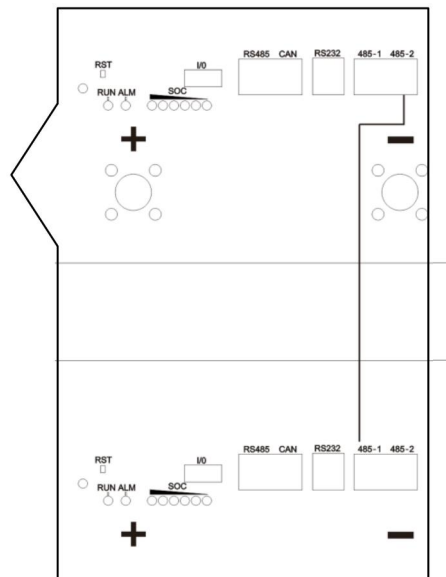

Part3: (3 cabinets)wiring diagram for the parallel connection of 15 pcs

4.5 Dial Code Switch Settings (parallel connection needed)

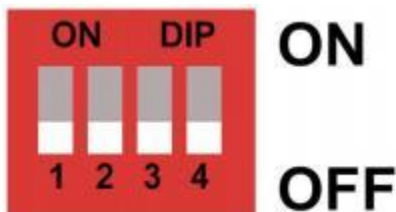

When the battery packs are connected in parallel, the dial code switch of each battery can be used to distinguish different Pack addresses. The hardware address can be set through the dial code switch on the board. (The automatic coding may encode the host to wake up the slave, after the host wakes up from the function to wake up automatically The definition of the dial code switch refer to the following table.

ADD	Dial switch position			
	#1	#2	#3	#4
1	ON	OFF	OFF	OFF
2	OFF	ON	OFF	OFF
3	ON	ON	OFF	OFF
4	OFF	OFF	ON	OFF
5	ON	OFF	ON	OFF
6	OFF	ON	ON	OFF
7	ON	ON	ON	OFF
8	OFF	OFF	OFF	ON
9	ON	OFF	OFF	ON
10	OFF	ON	OFF	ON
11	ON	ON	OFF	ON
12	OFF	OFF	ON	ON
13	ON	OFF	ON	ON
14	OFF	ON	ON	ON
15	ON	ON	ON	ON

4.6 Communication Function

1)RS232 communication



RS232 Port use 6P6C vertical RJ11 Socket	
RJ11 Pin	Define
Pin 2	NC(empty)
Pin 3	TX(computer receives data)
Pin 4	RX(computer sends data)
Pin 5	GND(ground)

BMS can communicate with the upper computer through RS232 interface, so that it can monitor all kinds of battery information, including battery voltage, current and temperature, working status etc. The default baud rate is 9600bps.

2)RS485-1 / CAN main communication

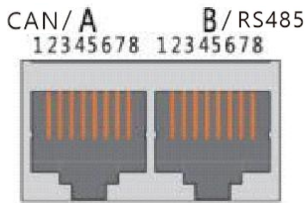

If you need to communicate with the monitoring device through RS485 or Can, the monitoring device will be used as the host, and the address setting range of other batteries will be 2~15 according to the polling data of the address.

The product adopts isolated communication design, supports RS485/CAN communication mode, RS485 communication default baud rate is 9600 bps, 8 bit data bit, 1 bit stop bit, no test bit; The default baud rate of CAN communication is 500Kbps;

RS485 & CAN use 8P8C vertical RJ45 socket			
RS485 PIN	Define	CAN PIN	Define
1、8	RS485-B1	1、2、3、6、8	NC
2、7	RS485-A1	5	CANL
3、6	GND	4	CANH
4、5	NC	7	GND

3)RS485-2 communication for parallel connection

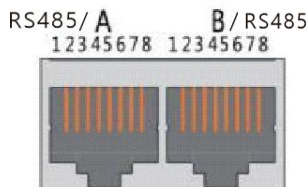

With dual RS485 interfaces, the default baud rate is 9600bps. If you need to communicate the batteries in parallel with the monitoring device or inverter, You need to plug the communication cable connecting the inverter and battery into port A (which is the right port in the actual product), and the parallel communication cables between the batteries should be staggered between ports A and B, so the host battery can read the information of each battery.

RS485-A & RS485- B use 8P8C vertical RJ45 socket			
RS485-A PIN	Define	RS485- B PIN	Define
1、8	RS485-B	1、8	RS485-B
2、7	RS485-A	2、7	RS485-A
3、6	GND	3、6	GND
4、5	NC	4、5	NC

4.7 LED Indication Function

The current power consumption and operation status of the product are shown through LED indicator Light (See Table 1, Table 2, and Table 3 for details) Working status indication.

State	Normal / Alarm / Protection	ON/OFF	RUN	ALM	SOC Indication LED						Instructions	
		●	●	●	●	●	●	●	●	●		
Power Off	Sleep	OFF	OFF	OFF	OFF	OFF	OFF	OFF	OFF	OFF	OFF	All off
Standby	Normal	ON	flash1	OFF	Indication by SOC						Standby	
	Alarm	ON	flash1	Flash3							Cell low voltage	
Charge	Normal	ON	ON	OFF	Indication by SOC (The top SOC Led Flash 2)						Maximum power LED flash(flash 2),ALM does not flash for over-charge warning	
	Alarm	ON	ON	Flash3								
	Over Charge Protection	ON	ON	OFF	ON	ON	ON	ON	ON	ON	If no mains supply, LED as standby	
	Temperature. Over-current Fault Protection	ON	OFF	ON	OFF	OFF	OFF	OFF	OFF	OFF	OFF	Close charge
Discharge	Normal	ON	Flash3	OFF	Indication by SOC							
	Alarm	ON	Flash3	Flash3								
	Under Discharge Protection	ON	OFF	OFF	OFF	OFF	OFF	OFF	OFF	OFF	OFF	Close discharge
	Temperature. Over-current. Short Circuit Fault Protection	ON	OFF	ON	OFF	OFF	OFF	OFF	OFF	OFF	OFF	Close discharge
Fault		OFF	OFF	ON	OFF	OFF	OFF	OFF	OFF	OFF	OFF	Close charge Close discharge

Capacity Indicator

State		Charge						Discharge					
Capacity indicator light		L6	L5	L4	L3	L2	L1	L6	L5	L4	L3	L2	L1
		●	●	●	●	●	●	●	●	●	●	●	●
electricity (%)	0 ~ 16.6%	OFF	OFF	OFF	OFF	OFF	flash 2	OFF	OFF	OFF	OFF	OFF	ON
	16.6 ~ 33.2%	OFF	OFF	OFF	OFF	flash 2	ON	OFF	OFF	OFF	OFF	ON	ON
	33.2 ~ 49.8%	OFF	OFF	OFF	flash 2	ON	ON	OFF	OFF	OFF	ON	ON	ON
	49.8 ~ 66.4%	OFF	OFF	flash 2	ON	ON	ON	OFF	OFF	ON	ON	ON	ON
	66.4 ~ 83.0%	OFF	flash 2	ON	ON	ON	ON	OFF	ON	ON	ON	ON	ON
	83.0~100%	flash 2	ON	ON	ON	ON	ON	ON	ON	ON	ON	ON	ON
Running light ●		ON						flash(flash 3)					

LED Flashing Instructions

Flash way	ON	OFF
Flash 1	0.25S	3.75S
Flash 2	0.5S	0.5S
Flash 3	0.5S	1.5S

Note:

The LED indicator alarm can be enabled or disabled through the host computer. The factory default is enabled.

4.8 LCD introduction

4.8.1 Reference physical image



4.8.2 Display rendering



4.8.3 Main Menu Page

After power on/sleep activation, the welcome interface will be displayed, and press the MENU key to enter the main menu page. As shown in the following figure:

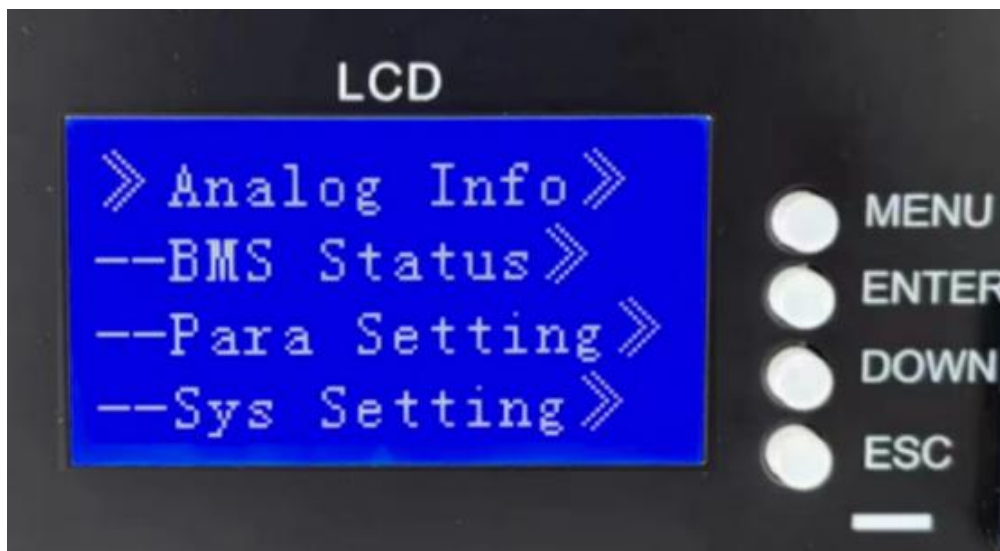

4.8.4 Page definition not displayed

Single cell over voltage alarm	Cell OV
Single low voltage alarm	Cell UV
Total pressure over voltage alarm	Pack OV
Total pressure low pressure alarm	Pack UV
Charging over current alarm	CHG OC
Discharge over current alarm	DSG OC
Charging high temperature alarm	CHG OT
Discharge high temperature alarm	DSG OT

Low temperature charging alarm	CHG UT
Low temperature discharge alarm	DSG UT
Environmental high temperature alarm	ENV OT
Environmental low temperature alarm	ENV UT
MOS high temperature alarm	MOS OT
Low battery	SOC Low
Single cell over voltage protection	Cell OVP
Single cell over discharge protection	Cell UVP
Overall Over voltage Protection	Pack OVP
Overall Over discharge Protection	Pack UVP
Charging over current protection	CHG OCP
Discharge over current protection	DSG OCP
Short circuit protection	SCP
Charger high-voltage protection	Charger OVP
Charger reverse connection	Charger in versed
Charging over temperature protection	CHG OTP
Discharge over temperature protection	DSG OTP
Low temperature protection for charging	CHG UTP
Low temperature discharge protection	DSG UTP
MOS high-temperature protection	MOS OTP
Environmental high temperature protection	ENV OTP
Environmental low-temperature protection	ENV UTP
Full charge	Fully
Charging MOS fault	CHG MOS Fault
Discharge MOS Fault	DSG MOS Fault
NTC malfunction	NTC Fault
Battery failure	Cell Fault
Sampling fault	Sampling Fault
Fault in current limiting plate	CCB Fault
Heating film malfunction	Heater Fault

4.8.5 Key Description

- 1) Each item starts with "» " or "--", where "» " represents the current position of the cursor, and pressing the DOWN key can, Move the cursor position downwards; A project that ends with "» " indicates that the project has content that is not displayed. Press the Enter key to enter the project The corresponding page.
- 2) Press ESC to return to the previous level directory; At any location, press the MENU key to return to the main menu page.
- 3) In sleep mode, press any button to activate the display screen.

4.8.6 Screen selection protocol:

The user selects the correct communication protocol version through buttons and passes the selected protocol version number back to the BMS motherboard Program to change the default communication protocol between BMS and the upper computer;

The selection menu for this function is placed in the system settings menu directory.

The menu structure is illustrated in the following figure:

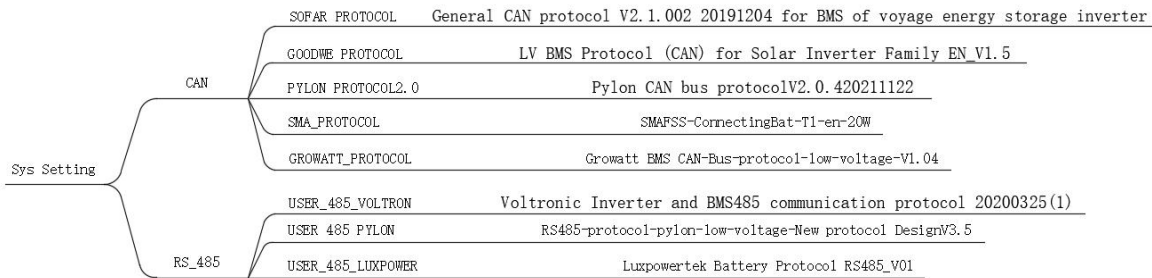

The protocol confirmation is shown below:



4.8.7 Hibernate/shut down

In normal operating mode, after 1 minute of no button operation, the system will enter sleep/shutdown mode. In shutdown/sleep mode In this state, operating any button will activate the display screen.

4.9 Sleep Mode

The system enters a low-power mode when any of the following conditions is met:

- 1.The monomer or overall over release protection is not removed within 30 seconds.
- 2.Press the button (3~6S) and release the button.
3. The lowest unit voltage is lower than the dormancy voltage, and the duration reaches the dormancy delay time (at the same time, meet the no communication, no protection, no equilibrium, no current).
- 4.The standby time is more than 24 hours (no communication, no charge and discharge, no city power).
5. Force the shutdown through the upper computer software. Before entering hibernation, ensure that the input is not connected with external voltage, otherwise it cannot enter the low power mode.

4.10 Awake Mode

When the system is in the low power mode and meets any of the following conditions, the system will exit the low power mode and enter the normal operation mode:

- 1.Access to the charger, and the output voltage of the charger shall be greater than 48V.
- 2.Press the button (3~6S) and release the button.

5 Installation and operation

5.1 Installation Location

Make sure that installation location should meet the following condition:

- 1) The area should be completely water-proof.
- 2) The floor should be flat and level.
- 3) No flammable or explosive materials.
- 4) The ambient temperature is within the range from 0°C to 50°C.
- 5) The temperature and humidity are maintained at a constant level.
- 6) There is just a little dust and dirt in the area.
- 7) The distance from heat source should be more than 2 meters.
- 8) The distance from air outlet of inverter is more than 0.5 meters.
- 9) Installation areas should avoid direct sunlight.
- 10)No forced ventilation requirement for battery module, but please avoid installing in a closed area. Ventilation shall avoid high salinity $\leq 30\%$, humidity $\leq 85\%$ and ambient temperature of 0 ~ 45 °C.

5.2 Installation Direction



Warning

Upside down	Sidelong	upright
		
NOT allowed	NOT allowed	NOT allowed

Figure 5-2

5.3 Installation Steps

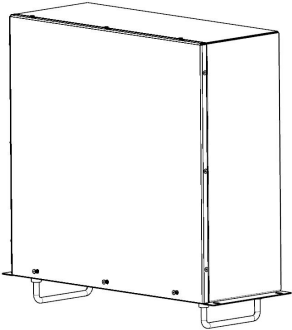
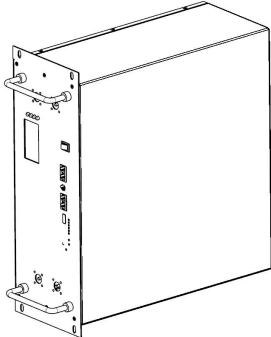
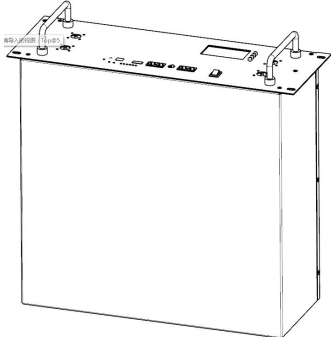

Warning

- 1) Follow local electric safety and installation policy, a suitable breaker between battery system and inverter is required.
- 2) All installation and operation must follow local electric standard and requirements.
- 3) When battery modules are paralleled, the system should be powered off before installation operation.

5.4 Assembly steps

1. Adjust the four foot pads on the cabinet to be level and stable with the ground, and place the battery module in the cabinet along the crossbeam;

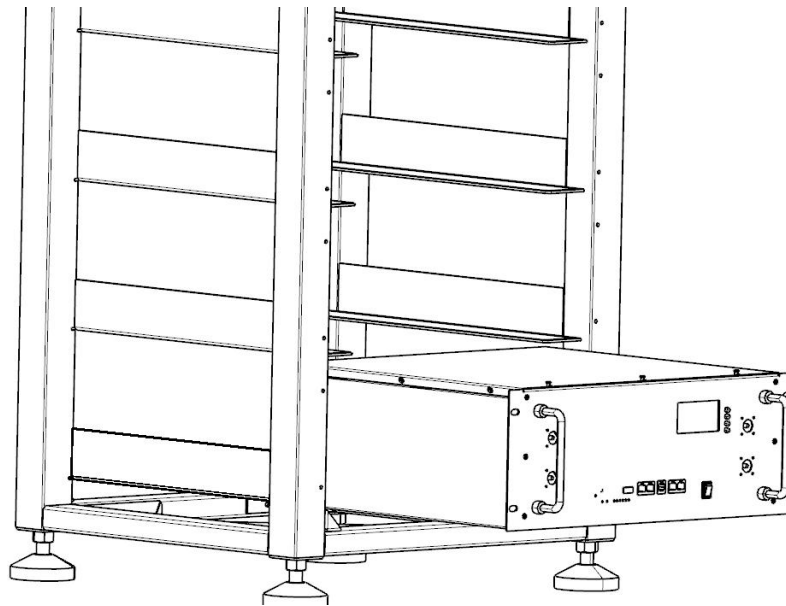

2. Fix the battery module to the cabinet using M5 stainless steel triple combination screws;

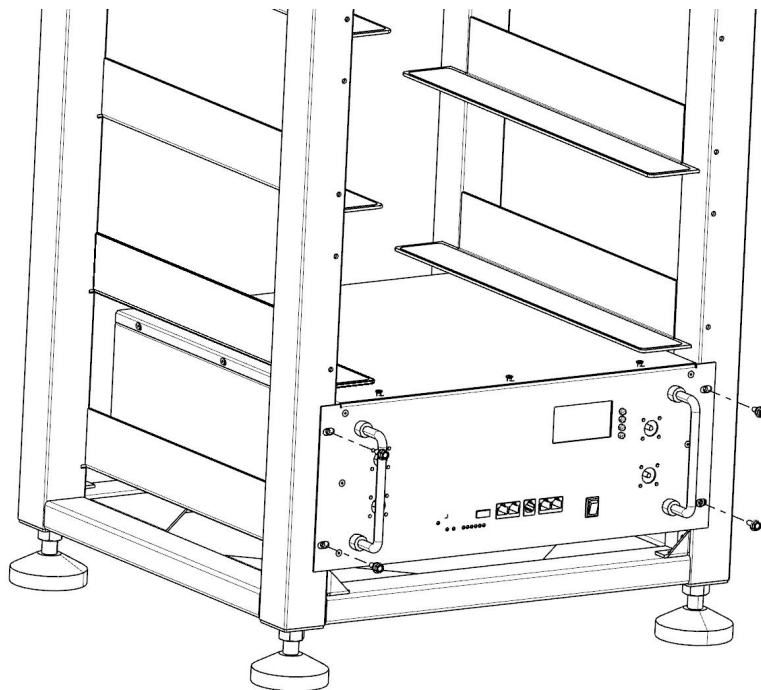

6 . Electrical Specification

(Unless there is special requirement, the test shall be done under temperature of $25 \pm 2^{\circ}\text{C}$ and with relative humidity of 45~85%.)

Items	Test Condition				Standard
6.1 Standard Charge	The standard charge means charge the battery in temperature below $25 \pm 3^{\circ}\text{C}$ with initial charge current of 50A(100Ah)/ 50A(200Ah)/ 140A(280Ah)and with constant voltage of 57.6V, then charge with constant voltage of 57.6V and with floating current taper to0.5A(100Ah)/ 1A(200Ah)/ 1A(280Ah) cut-off (Charger should be exclusively designed for lithium battery, with an accuracy of $\pm 0.05\text{V}$) within 6 hours.				/
6.2 Standard Discharge	After battery is charged fully in accordance with the standard and then discharge to voltage 43.2V with discharge current of 50A(100Ah)/ 100A(200Ah)/ 140A(280Ah).The minimum gap time between charge and discharge period is 30 minutes.				Minimum Capacity $\geq 95\%$ Capacity
6.3 Cycle Life	After the completion of 0.2C charge and 30 minutes' rest, discharge to 80% DOD with constant current of 0.2C in the ($25 \pm 3^{\circ}\text{C}$) environment, then carry out the next cycle, after 6000 cycles, rest it for 1 day and test the capacity.				Capacity $\geq 80\%$ Minimum Capacity
6.4 Discharge Character	Discharge current	Discharge Temperature			At -10°C : Discharge Capacity $\geq 50\%$ At 0°C : Discharge capacity $\geq 80\%$ At 25°C Discharge capacity $\geq 100\%$ At 40°C Discharge capacity $\geq 100\%$
	0.5C	-10°C	0°C	25°C 40°C	
	Batteries shall be charged according to 6.1 and discharged in accordance with the above mentioned temperature. The discharge capacity shall meet the standard. Batteries shall be stored for 6~8 hours at the test temperature.				

7. BMS

7.1 BMS System Schematic Diagram

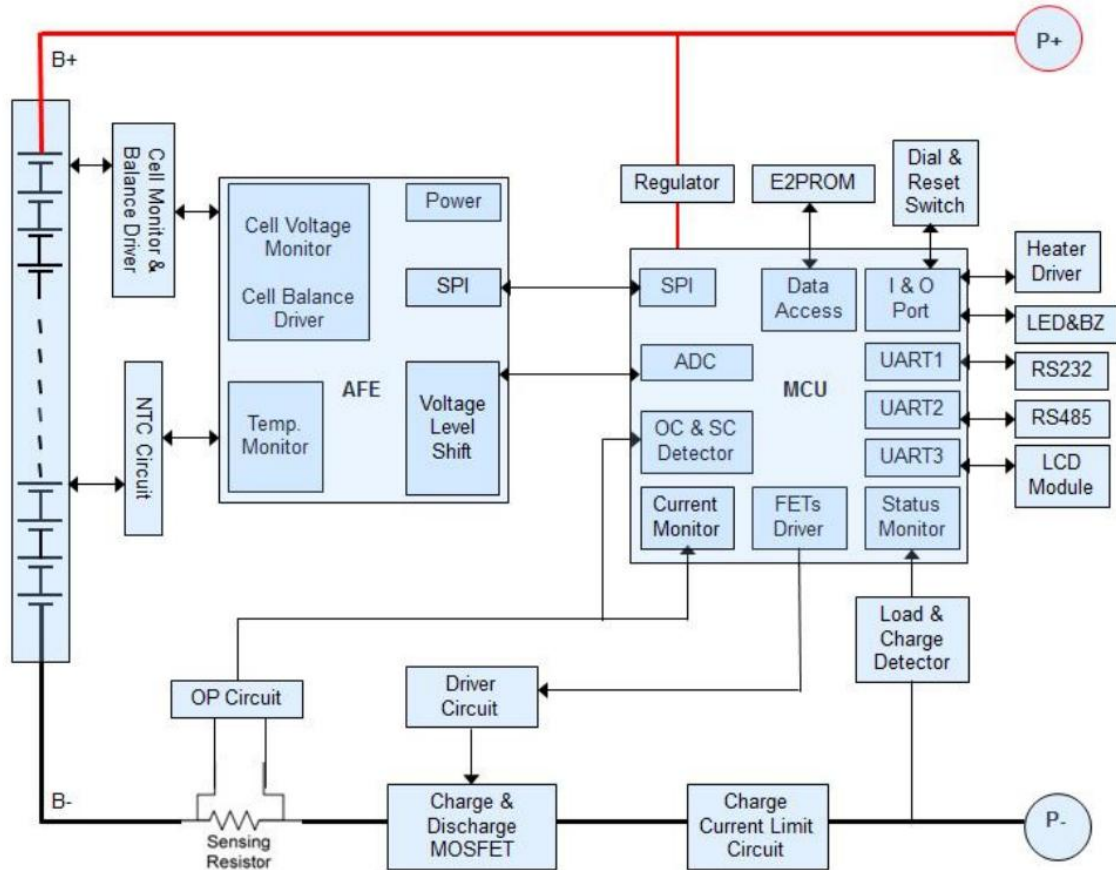

7.2 BMS Parameter

No.	Item	51.2V 100Ah	51.2V 200Ah	51.2V 280Ah
1	Power Consumption	Low power consumption mode	$\leq 100\mu\text{A}$	$\leq 100\mu\text{A}$
2	Over charge Protection	Over charge detection voltage	3.65V	3.65V
		Over charge release voltage	3.38V	3.38V
3	Over discharge protection	Over discharge detection voltage	2.7V	2.7V
		Over discharge release voltage	2.95V	2.95V
4	Over current protection	Charging over current detection current (detection time)	110A (1S)	110A (1S)
		Discharging over current detection current 1 (detection time)	110A (1S)	110A (1S)
		Discharging over current Detection current 2 (detection time)	$\geq 150\text{A}$ 100ms	$\geq 150\text{A}$ 100ms
5	Temp. Protection	Detection temperature	$65 \pm 2\text{C}$	$65 \pm 2\text{C}$
6	Balance	Balance voltage	3.5V	3.5V

8. Product Life

The design life of this product is 10 years.

9. Transportation

During transportation, please keep the battery from acutely vibration, impacting, over-exposure to the sun and drenching.

10 Emergency Situations

10.1 Battery Leakage

If the battery pack leaks electrolyte, avoid contact with the leaking liquid or gas. If one is exposed to the leaked substance, immediately perform the actions described below.

- 1) Inhalation: Evacuate contaminated area and seek medical aid.
 - 2) Contact with eyes: Rinse eyes with flowing water for 15 minutes and seek medical aid.
 - 3) Contact with skin: Wash affected area thoroughly with soap water and seek medical aid.
- Ingestion: Induce vomiting and seek medical aid.

10.2 On Fire

NO WATER!

Only dry powder fire or carbon dioxide extinguisher can be used; if possible, move the battery module to a safe area before it catches fire.

10.3 Wet Batteries

If the module is wet or submerged in water, do not let people access it, then contact us or an authorized dealer for technical support. Cut off all power switch on inverter side.

10.4 Damaged Batteries

Damaged batteries are dangerous and must be handled with utmost care. They are not fit for use and may pose a danger to people or property. If the module seems to be damaged, pack it in its original container, then return it to authorized dealer.

**Warning**

Damaged batteries may leak electrolyte or produce flammable gas.

11 Remarks**11.1 Maintenance**

It is required to charge the battery at least once every 6 months, for this charge maintenance make sure the SOC is charged to higher than 85%.

Check installation environment such as dust, water, insect etc. Make sure it is suitable for IP20 battery system. Connection of power connector, grounding point, power cable and screw are suggested to be checked every year.

Parts List

Item	Part Name	Description	Unit	Quantity
1	Network line	0.3 meters network line	PCS	1
2	Network cable	2 meters of inverter communication network cable	PCS	1
3	Positive and negative pole line	A pair of red and black 0.22 meters parallel positive and negative electrode line 6	PCS	1
4	Ground yellow and green line	1.5 meters grounding yellow-green line 12	PCS	1
5				
6				
7				
8				
9				

Maintenance Record

Dear user.thank you for selecting our product,Please fill in and keep the warranty card for better services.

Attn: _____ Product No. : _____

Tel : _____ E-mail: _____

Purchase Date: _____

Address: _____

Maintenance Record			
Date of repair	Content	Maintenance Personnel	Note