

# 10kW 51.2V Power Stacked Lithium Battery



## USER INSTRUCTION

This power Stacked mode lifepo4 lithium battery belongs to one of the series of household energy storage products that are independently designed and developed. It has long cycle life, high safety standard BMS software protection and strong housing, exquisite looks, and easy installation, etc. It is widely used in energy storage system with off-grid inverters, on-off grid inverters and hybrid inverters.

## Catalogue











<b>(Revision History)</b> .....	<b>3</b>
<b>1. Symbol Description</b> .....	<b>4</b>
<b>2. Safety Precautions</b> .....	<b>5</b>
2.1 Before Connecting .....	5
2.2 In Using .....	5
<b>3. Introduction</b> .....	<b>6</b>
3.1 Features .....	7
3.2 Size .....	8
3.3 Specification Parameters .....	9
3.4 Equipment interface instruction .....	10
3.5 Operation panel .....	13
<b>4. Safe Handling of Lithium-iron ESS Batteries Guide</b> .....	<b>14</b>
4.1 Solution Diagram .....	14
4.2 Danger Label .....	14
4.3 Tool .....	15
4.4 Safety Gear .....	15
<b>5. Installation and operation</b> .....	<b>15</b>
5.1 Installation Location .....	15
5.2 Installation Steps .....	16
5.3 Assembly steps .....	16
5.4 System turns on .....	18
5.5 System turns off .....	18
<b>6. Battery layer</b> .....	<b>19</b>
6.1 BMS System Schematic Diagram .....	19
6.2 BMS Parameter .....	19
6.3 Dial Code Switch Settings (parallel connection needed) .....	20
6.4 BMS Communication port .....	20
6.5 State indication .....	21
6.6 Capacity indication .....	22
6.7 Light Blink explanation .....	22
<b>7. Inverter layer</b> .....	<b>23</b>

7.1 LCD Display Icons .....	23
7.2 Real-time data view method .....	25
7.3 Setting parameter .....	26
7.4 AC Output Mode .....	31
7.5 Battery Charging Mode .....	32
7.6 Fault Reference Code .....	33
<b>8. Emergency Situations .....</b>	<b>37</b>
8.1 Battery Leakage .....	37
8.2 On Fire .....	37
8.3 Wet Batteries .....	37
8.4 Damaged Batteries .....	37
<b>9. Remarks .....</b>	<b>37</b>
9.1 Recycle and Disposal .....	37
9.2 Maintenance .....	37
<b>Parts List .....</b>	<b>38</b>
<b>Maintenance Record .....</b>	<b>39</b>

(Revision History)

Ver.No	Date	Revised Content	Reasons for Change	Reviser	Approve
A0	2024.04.11	First Edition	First Draft	Zhangdigen	
A1	2024.07.23	Second Edition	Cancel the combiner box	Zhangdigen	

## 1. Symbol Description

	Do not place near open fire or flammable materials.
	A potential hazard exists when the equipment is working. Wear personal protective equipment during operation.
	Warning electric shock. Power off the equipment before any operation.
	Grounding: indicate PE cable connection position.
	Do not place in areas accessible to children.
	Keep the battery away from open fire or ignition sources.
	Read the product and operation manual before operating the battery system.
	Label for Waste Electrical and Electronic Equipment (WEEE) Directive (2012/19/EU.)
	The certificate label for CE.
	Recycle label.

## 2. Safety Precautions



### Alert

- 1) It is important and necessary to read the user manual carefully (and attachment) before installing or using battery. Failure to do so or to follow any instruction or warning in this document can result in electrical shock, serious injury, and death, or damage battery, potentially rendering it unusable.
- 2) When battery is stored for a long time, it is required to charge once every 6 months, and the SOC should be no less than 50%.
- 3) After battery module cannot be discharged, it needs to be recharged within 12h.
- 4) Do not connect power terminal reversely.
- 5) All power supplies must be disconnected during maintenance.
- 6) Please contact the supplier within 24 hours if there is something abnormal.
- 7) Do not use any liquid to clean the battery.
- 8) Do not expose battery to flammable or irritating chemicals or vapor.
- 9) Do not paint any part of battery, including any internal or external components.
- 10) Do not connect battery with PV solar wiring directly.
- 11) Do not install or use this product beyond provisions of the manual.
- 12) Direct or indirect damages caused by the above reasons are not covered by warranty claim.



### Warning

#### 2.1 Before Connecting

- 1) Please check the external packaging condition before unpacking. If it is damaged, contact corresponding local retailer.
- 2) After unpacking, please check the products and spare parts according to spare parts list. If the product is damaged or missing, please contact your local retailer.
- 3) Connect to specified matching inverter.
- 4) Before installation, be sure to cut off the grid power and make sure battery switch is on OFF mode.
- 5) It is prohibited to connect the battery and AC power directly.
- 6) All electrical wiring must be connected in accordance with local regulations.
- 7) Please ensure that electrical performance of battery system is compatible with the equipment.
- 8) The installation onsite shall be equipped with fire-fighting facilities that meet relevant requirements, such as fire sand, dry powder fire extinguisher, etc.

#### 2.2 In Using

- 1) If battery system needs to be moved or repaired, power must be cut off and battery is completely shut down.

- 2) It is prohibited to connect battery with different types of battery.
- 3) Do not connect battery to faulty inverter.
- 4) Except for personnel from The Company or other authorized personnel, batteries shall not be opened, repaired or disassembled. The company shall not bear any liability or responsibility caused by violation of any safety operation or design standard, production standard, equipment safety standards or any other standards or requirements.

### 3. Introduction

This power Stacked mode lifepo4 lithium battery is a new energy storage product developed and produced by The Company, which can provide reliable power supply for all kinds of equipment or systems.



Figure 3-1

### 3.1 Features

- 1) When multiple modules are paralleling connected, module addresses are set automatically.
- 2) Support for upgrading the battery module from the upper controller through 232 or 485 communication.
- 3) The module is non-toxic, non-polluting and environmentally friendly.
- 4) Cathode material is made from LiFePO4 with safety performance and long cycle life.
- 5) Battery management system (BMS) has protection functions including over- discharge, over-charge, over-current and high/low temperature.
- 6) The system can automatically manage charge and discharge state and balance voltage of each cell.
- 7) Flexible configuration, multiple battery modules can be connected to expand capacity .
- 8) Adopted self-cooling mode rapidly reduced system entire noise.
- 9) The module has less self-discharge, up to 6 months without charging it on shelf, no memory effect, excellent performance of shallow charge and discharge.

### Functions

Protection and Alarm	Management and monitor
Charge/Discharge End	Cell Balance
Over voltage Charging Protection	Intelligent Charge Model
Under Voltage Discharging Protection	Charge/Discharge Current Limit
Charge/Discharge Over current Protection	Capacity Retention Calculate
High/Low Temperature Protection	Short Circuit Protection
History Record	Adjustable parameter settings

### 3.2 Size

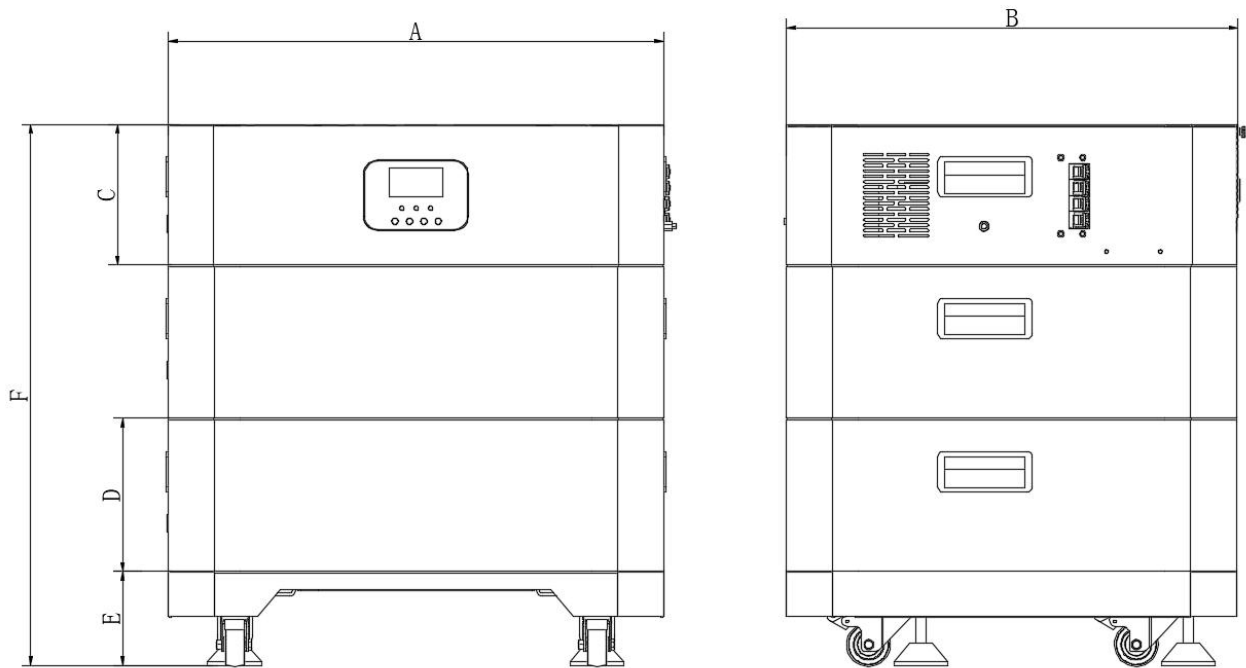
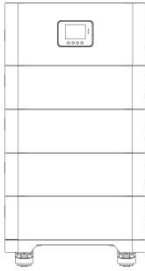



**Figure 3-2**

model Size					
A	B	C	D	E	F
750 mm	700 mm	176mm	171 mm	105 mm	623mm



### 3.3 Specification Parameters

Appearance			
Basic Parameters	Inverter layer ×1 Battery layer×4	Inverter layer ×1 Battery layer×5	Inverter layer ×1 Battery layer×6
Product Size	750×700×965mm	750×700×1136mm	750×700×1307mm
Product Weight	~390kg	~475kg	~560kg
<b>Battery parameters</b>			
Nominal Voltage	51.2V		
Nominal Capacity	40.96kWh	51.2kWh	61.44kWh
Standard Discharge Current	100A		
Standard Charge Current	50A		
Working Voltage	43.2-57.6V		
<b>AC Input/Output</b>			
Rated AC Output Power	10000W		
Input Voltage and Frequency	170-280VAC/50HZ or 60HZ		
Output Voltage	230VAC		
AC Input/Output Rated Current	40A		
Max. Continuous AC Passthrough	50A		
<b>PV</b>			
PV Input Power	5500W+5500W		
PV input Voltage	500V		
MPPT Voltage	120-425V		
PV Charging Current	22A+22A		
<b>Overall parameters</b>			
Communicate	RS485/CAN/ WIFI(Optional )		
Operation Temperature	Charge: 0°C~55°C Discharge: -30°C~55°C		
Storage Temperature	-20~55 °C		

Ambient Humidity	≤85% (RH) No Condensation
Working Altitude	≤2000m
Cooling Method	Fan cooled
Service Life	10 years+ (25°C)

Note: Our company will continuously update and upgrade our products. Please refer to the actual products received.

### 3.4 Equipment interface instruction

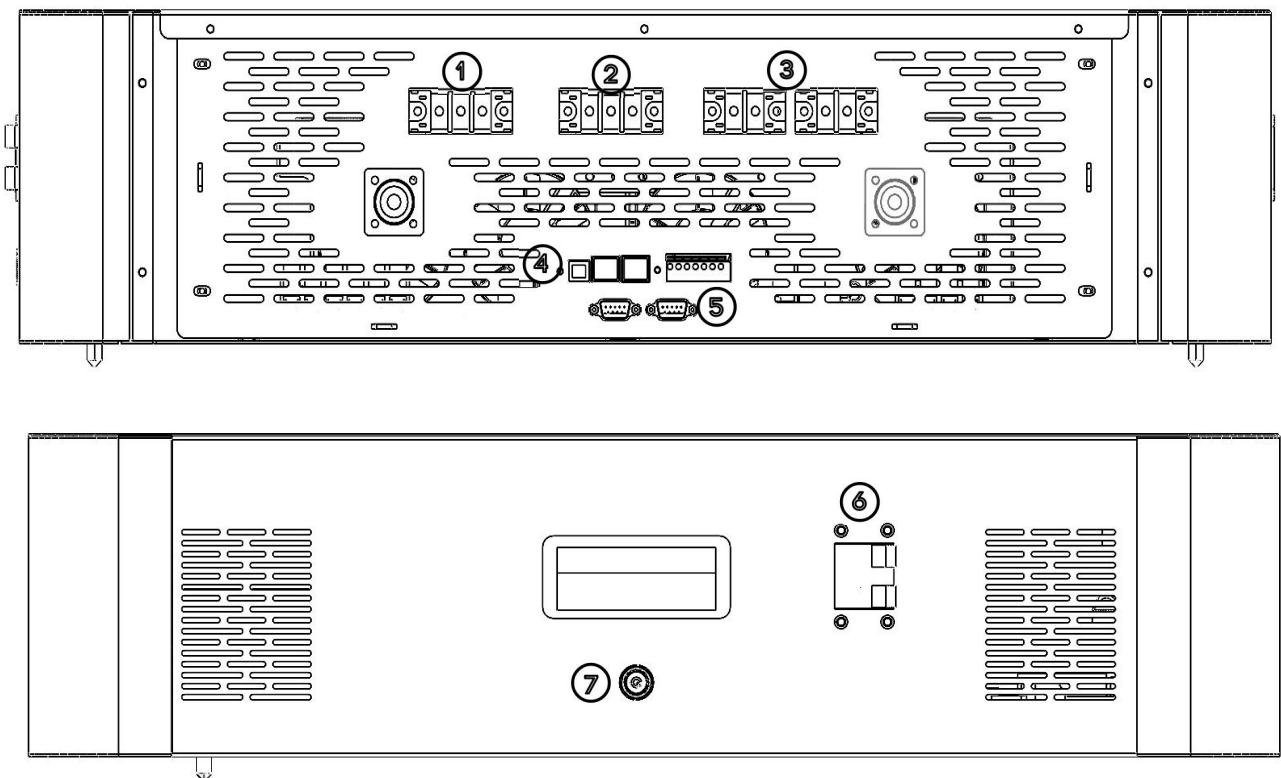

Figure 3-3

- ① **AC IN:** inverter AC input ground wire plus live wire plus neutral wire--Connect using 10AWG cable
- ② **AC OUT:** inverter AC output ground wire plus live wire plus neutral wire--Connect using 10AWG cable
- ③ **PV:** PV positive and negative charging interfaces--Connect using 12AWG cable
- ④ **Communication port:**Connect WIFI and battery via RJ45 8P8C
- ⑤ **Parallel connection:** Parallel interface between inverters (optional)
- ⑥ **Breaker:**control circuit output, turn the switch to ON when use
- ⑦ **Start button:**System startup switch, press the button to activate the inverters layer

➤ **AC IN**

Recommended wire diameter: 8mm<sup>2</sup>/8AWG; The input current for the communication limit is 40A, and the maximum bypass current is 50A. Recommended air switch or circuit breaker model 2P-63A.

➤ **AC OUT**

Recommended wire diameter: 8mm<sup>2</sup>/8AWG; The output current of the communication limit is 40A, and the maximum bypass current is 50A. Recommended air switch or circuit breaker model 2P-63A.

➤ **PV**

Recommended wiring diameter: 5mm<sup>2</sup>/10AWG; The maximum PV input current is 22A. Recommended air switch or circuit breaker model 2P-25A.

➤ **RS485-2/CAN**

The RJ45 communication port can communicate with the lithium battery BMS via RS485/CAN.

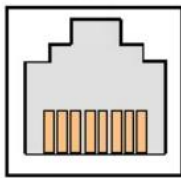

8 1  
RS485-2/CAN

Pin	Definition
1	5V +
2	GND
3	/
4	CANH
5	CANL
6	/
7	RS485A
8	RS485B

➤ **WIFI(Optional)**

The RJ45 8P8C port allows us to connect and use our self-developed RS485 to WIFI/GPRS communication module. After selecting this module, we can connect our reverse control all-in-one machine through a mobile app, and view the operating parameters and status of the reverse control all-in-one machine through the mobile app.

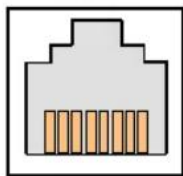

8 1  
RS485-1/WIFI

Pin	Definition
1	5V +
2	GND
3	/
4	/
5	/
6	/
7	RS485A
8	RS485B

**Note :**

The Wi-Fi/GPRS data acquisition module need to be purchased separately. User can scan the QR code to download the mobile APP



➤ **USB**

This port is a USB communication port, which can be used for USB communication with the selected upper computer software of our company (Need to apply for). To use this port, the corresponding “USB to serial port chip CH340T driver” should be installed in the computer.

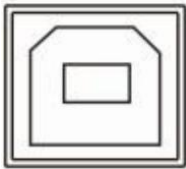

➤ **Dry node function**

Dry contact port with 4 functions:

1. **Remote switch on/off** : When pin 1 is connected with pin 2, the inverter will switched off the AC output.
2. **Switching signal output** : When the voltage of battery reaches the under-voltage limit voltage (parameter15), pin 3 to pin 1 voltage is 0v, When the battery charging/discharging normally pin 3 to pin 1 voltage is 5V.
3. **Battery temperature sampling** : Pin 1 & Pin 4 can be used for battery temperature sampling compensation.
4. **Generator remote start/stop** : When the voltage of battery reaches the under-voltage alarm voltage (parameter14) or voltage point of utility switch to battery (parameter &4), pin 6 to pin 5 normal open, pin 7 to pin 5 normal close. When the voltage of battery reaches the voltage point of battery switch to utility(parameter 05) or battery is full. pin 6 to pin 5 normal close, pin 7 to pin 5 normal open.(Pin 5/6/7 outputs 125Vac/1A,230Vac/1A,30Vdc/1A.)

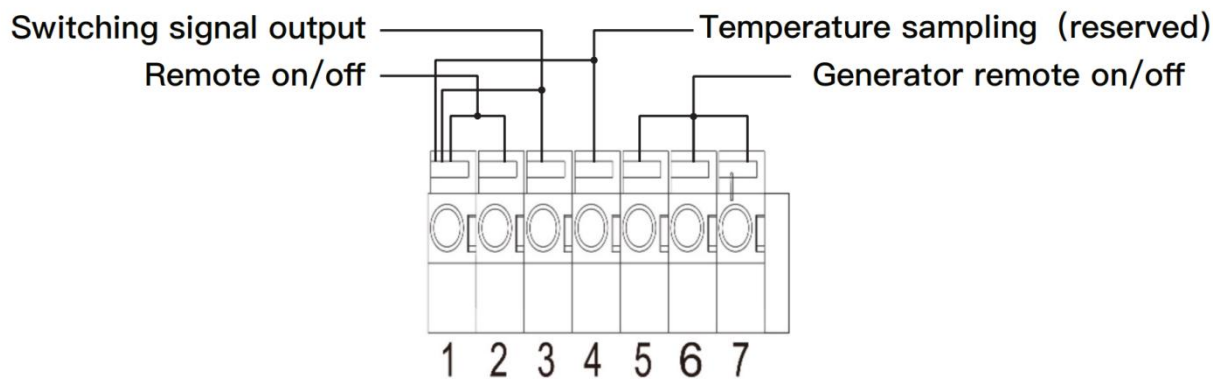

Note : If you need to use the remote start/stop function of the generator with dry contact, ensure that the generator has ATS and supports remote start/stop.





### ➤ Breaker

AC IN:Control the AC input switch. Set to ON mode during use.

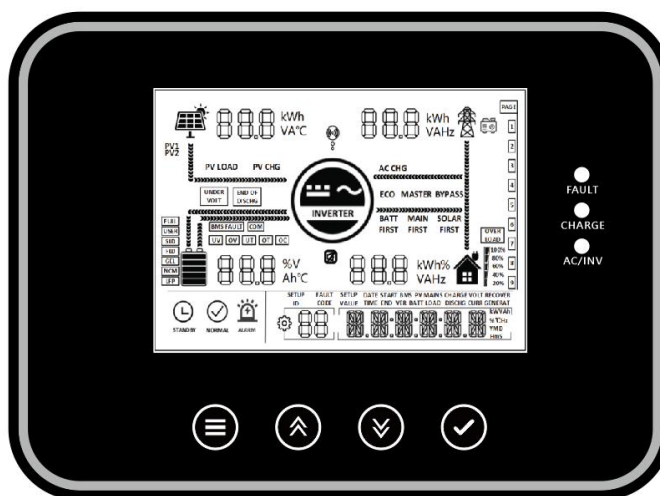
### 3.5 Operation panel

The operation and display panel ,shown in below chart,is on the front panel of the inverter.It includes three indicators, four function keys and a LCD display, indicating the operating status and input/output power information.



Function Key	Description
 SET	Enter/exit setting menu
 UP	Last option
 DOWN	Next option
 ENT	Confirm/enter option under setting menu

Indicator light	Color	Description
AC/INV	Yellow	Constant on: mains supply output
		Flashing: inverter output
CHARGE	Green	Constant on: charge completed
		Flashing: battery in charge
FAULT	Red	Flashing: error occur

## 4. Safe Handling of Lithium-iron ESS Batteries Guide

### 4.1 Solution Diagram

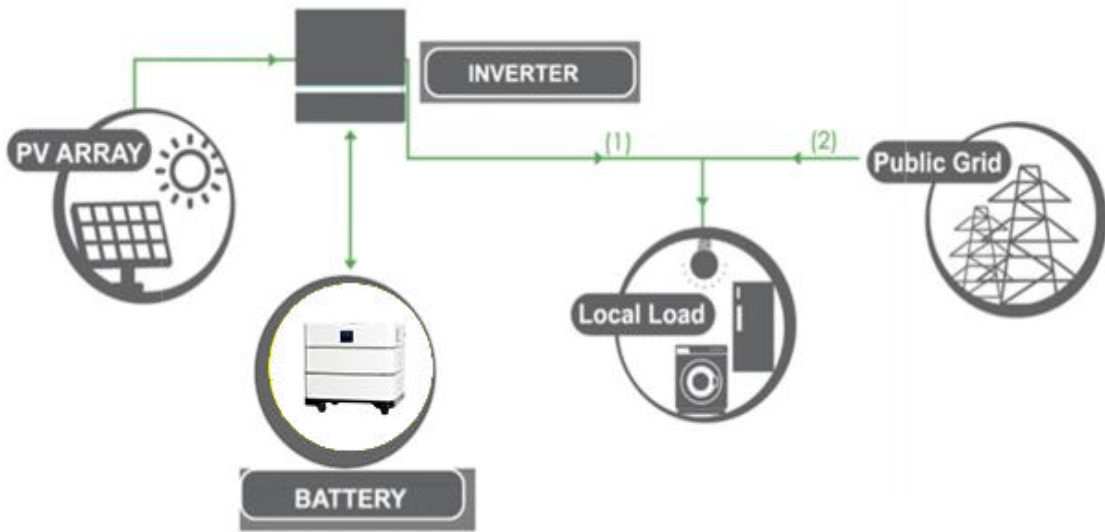

Figure 4-1

### 4.2 Danger Label



Figure 4-2

### 4.3 Tool



Wire Cutter



Modular Crimping Pliers



Screwdriver



Electric drill

Note :

Properly use insulated tools to prevent accidental electric shock or short circuits. If tools are not insulated, cover the entire exposed metal surfaces of available tools with electrical tape except their tips.

### 4.4 Safety Gear

It is recommended to wear the following safety gear when dealing with battery pack.



Insulated Gloves



Safety Goggles



Safety Shoes

## 5. Installation and operation

### 5.1 Installation Location

Make sure that installation location should meet the following condition:

- 1) The area should be completely water-proof.
- 2) The floor should be flat and level.
- 3) No flammable or explosive materials.
- 4) The ambient temperature is within the range from 0°C to 50°C.
- 5) The temperature and humidity are maintained at a constant level.
- 6) There is just a little dust and dirt in the area.
- 7) The distance from heat source should be more than 2 meters.
- 8) The distance from air outlet of inverter is more than 0.5 meters.
- 9) Installation areas should avoid direct sunlight.
- 10) No forced ventilation requirement for battery module, but please avoid installing in a closed area. Ventilation shall avoid high salinity  $\leq 30\%$ , humidity  $\leq 85\%$  and ambient temperature of 0 ~ 45°C.

## 5.2 Installation Steps



### Warning

- 1) Follow local electrical safety and installation policies and use appropriate circuit breakers on the AC input, AC output, and photovoltaic input circuits of the all-in-one machine.
- 2) All installation and operation must follow local electric standard and requirements.
- 3) When battery modules are paralleled, the system should be powered off before installation operation.

## 5.3 Assembly steps



1. Adjust the four foot pads on the base layer to be level and stable with the ground. Place the base neatly against the wall (not shaking).

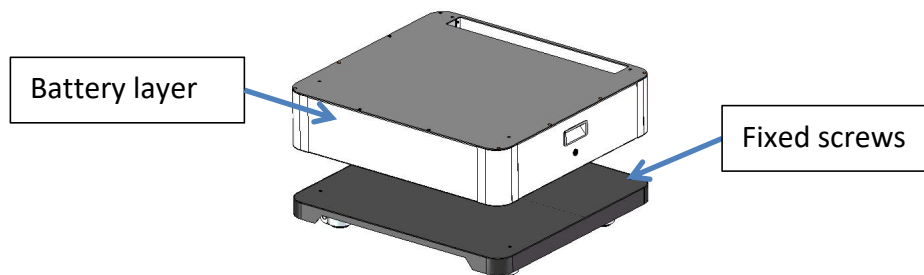

2. Align the direction, then insert the battery layer into the base (lower layer) and secure it with M6×10 screws.

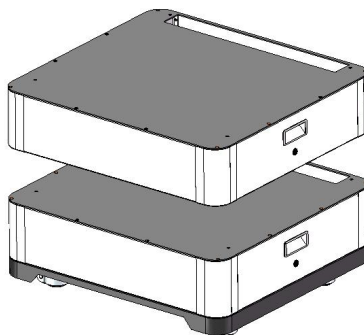

3. After aligning the direction, insert the second battery layer into the first battery layer already placed on the base, and fix the module with M6×10 screws. (Multiple batteries can repeat step 3.)



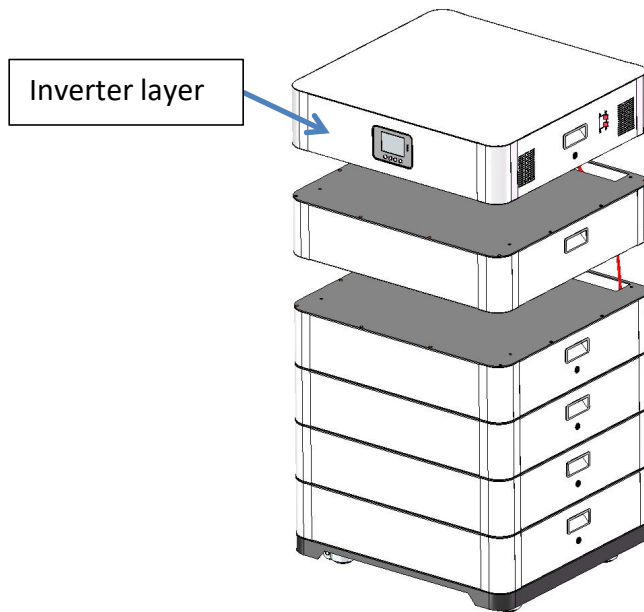

4. Align the direction and insert the inverter layer downwards into the battery layer, and fix the module with M6×10 screws.

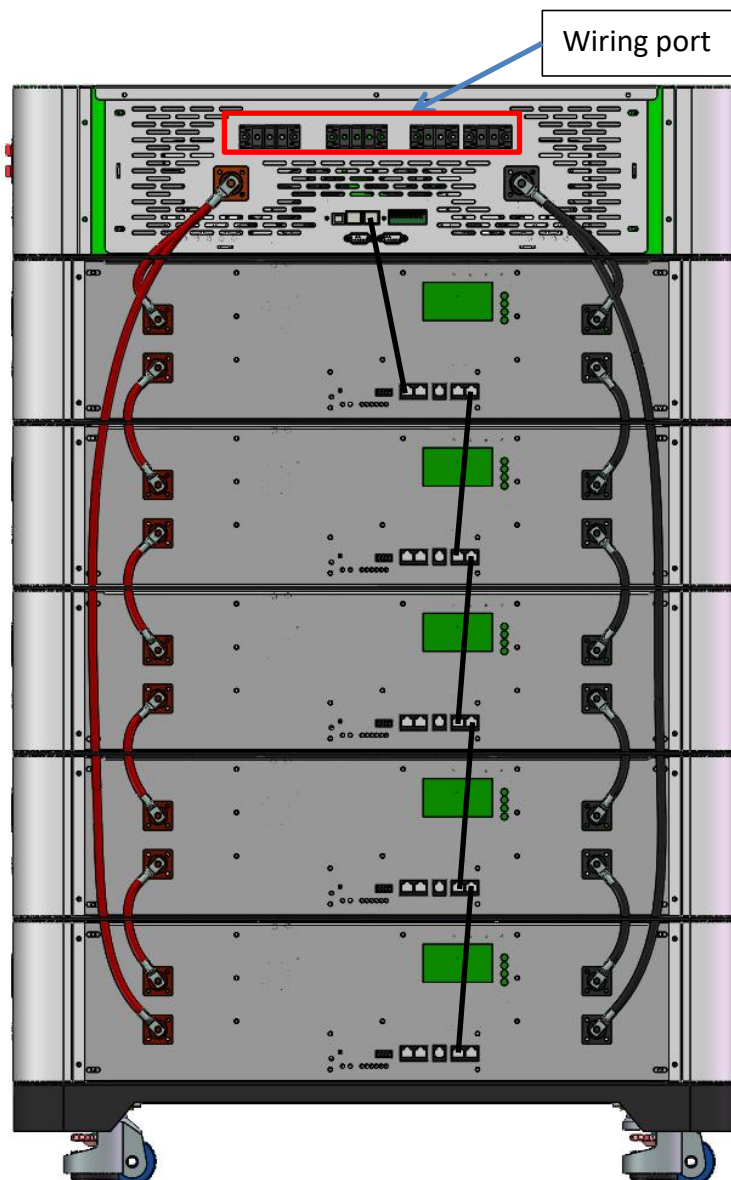

5. Open the back panel of the inverter and you can wire it here.

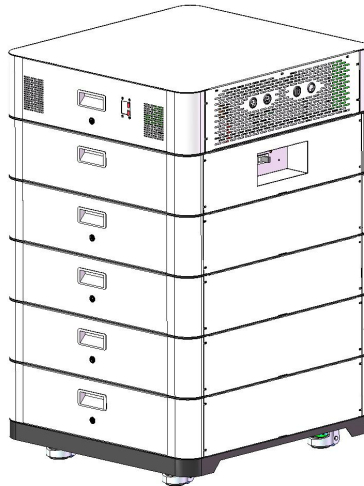

6. After wiring is completed, cover the back panel.

#### **5.4 System turns on**

**Warning:** Double check all the power cables and communication cables. Check all the power switches are OFF.

System turns on step:

- 1) Check all cables are connected correctly. Check grounding is connected.
- 2) If necessary, turn on the switch at inverter's battery side or between inverter and battery. If possible, turn on AC or PV power source to wake up inverter.
- 3) Open protect cover of Power switch. And turn on power switch.
- 4) Switch all the battery racks' Isolating Switch to on position.
- 5) Press the battery START button in turn, turn on the START metal button of the slave battery firstly, and finally turn on the START button of the master battery .
- 6) If no alarm ,the battery system will be ready for charging and discharge with PCS.

#### **5.5 System turns off**

When failure or before service, must turn the battery storage system off:

- 1) Turn off inverter or power supply on DC side.
- 2) Turn off the switch between PCS and battery system.
- 3) Switch Isolating Switch to off position. (Switch off the slave battery firstly, finally switch off the master battery.)

Note:

- 1) One battery system shall just have one master, all the others are slaves. (The one on the extreme side connected to inverter is the master battery.)
- 2) It is forbidden to switch off the Isolating Switch during charging and discharging.

## 6. Battery layer

### 6.1 BMS System Schematic Diagram

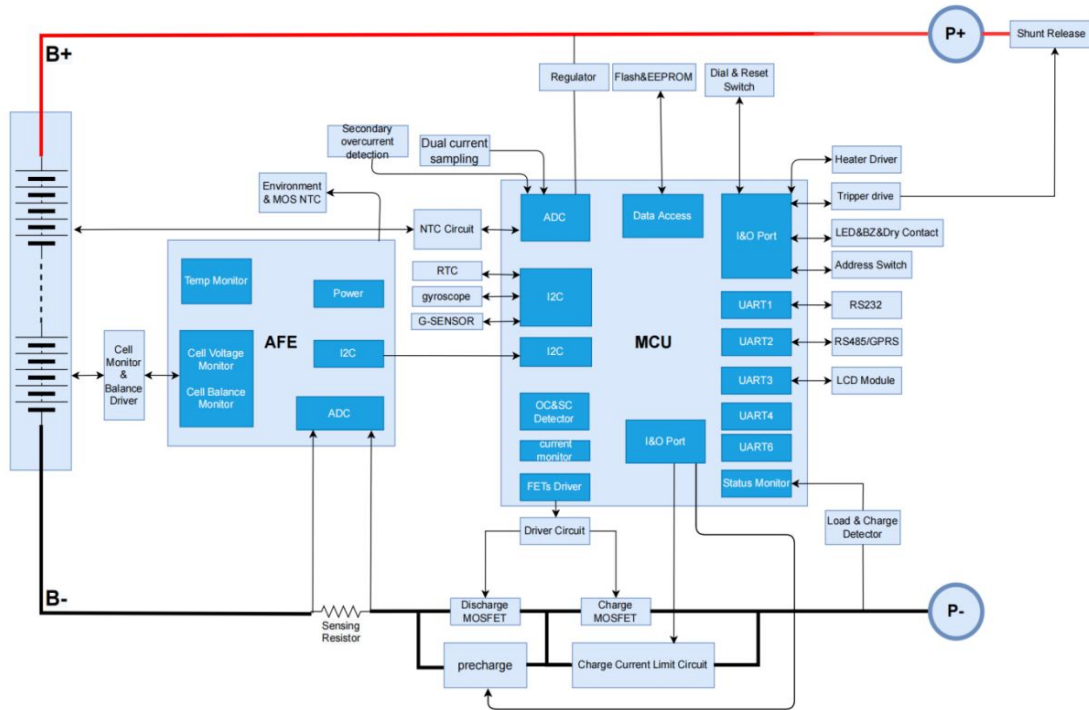

### 6.2 BMS Parameter

No.	Item		
1	Power Consumption	Low power consumption mode	$\leq 100\mu\text{A}$
2	Over charge Protection	Over charge detection voltage	3.65V
		Over charge release voltage	3.38V
3	Over discharge protection	Over discharge detection voltage	2.7V
		Over discharge release voltage	2.95V
4	Over current protection	Charge Over current Alarm	105A
		Charging Over current Protection	110A/1.0S
		Discharge Overflow Warning	-105A
		Discharge over-current protection	-110A/1.0S
5	Temp. Protection	Detection temperature	$65\pm 2^\circ\text{C}$
6	Balance	Balance voltage	3.5V

### 6.3 Dial Code Switch Settings (parallel connection needed)

When the battery packs are connected in parallel, the dial code switch of each battery can be used to distinguish different Pack addresses. The hardware address can be set through the dial code switch on the board. The definition of the dial code switch refer to the following table.

ADD	Dial switch position			
	#1	#2	#3	#4
1	ON	OFF	OFF	OFF
2	OFF	ON	OFF	OFF
3	ON	ON	OFF	OFF
4	OFF	OFF	ON	OFF
5	ON	OFF	ON	OFF
6	OFF	ON	ON	OFF
7	ON	ON	ON	OFF
8	OFF	OFF	OFF	ON
9	ON	OFF	OFF	ON
10	OFF	ON	OFF	ON
11	ON	ON	OFF	ON
12	OFF	OFF	ON	ON
13	ON	OFF	ON	ON
14	OFF	ON	ON	ON
15	ON	ON	ON	ON

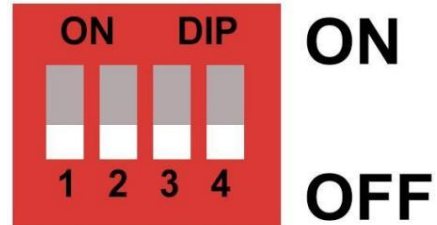

### 6.4 BMS Communication port

#### ➤ RS485:

The default baud rate is 9600bps, which is used for communication with the inverter. When this battery is the host, it can summarize slave data and communicate with the inverter.

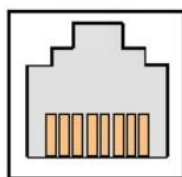

8 1  
RS485

Pin	Definition
1、8	RS485-B
2、7	RS485-A
3、6	GND
4、5	NC

➤ **CAN:**

The default baud rate is 500K, and this interface is used for communication with the inverter. When this battery is the host, it can summarize slave data and communicate with the inverter.

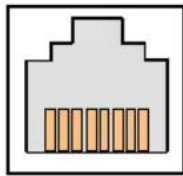

8 1  
CAN

Pin	Definition
1、3、6、7、8	NC
2	GND
4	CAN-H
5	CAN-L

➤ **Parallel RS485**

You can view the information of the PACK, with a default baud rate of 9600bps. To communicate with the monitoring device through RS485, the monitoring device serves as the host and sets the address range from 2 to 15 based on address polling data.

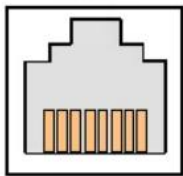

8 1  
485-1

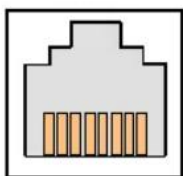

8 1  
485-2

Pin	485-1 Definition
1、8	RS485-B
2、7	RS485-A
3、6	GND
4	GND
5	UP-IN

Pin	485-2 Definition
1、8	RS485-B
2、7	RS485-A
3、6	GND
4	GND
5	DN-OP+

The parallel machine has dual RS485 interfaces. The first battery that communicates with the inverter serves as the main unit, and the 485-2 of the main unit is connected to the 485-1 of the next slave unit. The communication interfaces of each battery are connected in this staggered order, so that the main battery can read the information of each battery.

**6.5 State indication**

State	Normal / Alarm / Protection	ON/OFF	RUN	ALM	SOC Indication LED						Instructions	
		●	●	●	●	●	●	●	●	●		
Power Off	Sleep	OFF	OFF	OFF	OFF	OFF	OFF	OFF	OFF	OFF	OFF	All off
Standby	Normal	ON	flash1	OFF	Indication by SOC						Standby	
	Alarm	ON	flash1	Flash3	Indication by SOC						Cell low voltage	
Charge	Normal	ON	ON	OFF	Indication by SOC						Maximum power LED	

	Alarm	ON	ON	Flash3	(The top SOC Led Flash 2)						flash(flash 2),ALM does not flash for over-charge warning
	Over Charge Protection	ON	ON	OFF	ON	ON	ON	ON	ON	ON	If no mains supply, LED as standby
	Temperature. Over-current Fault Protection	ON	OFF	ON	OFF	OFF	OFF	OFF	OFF	OFF	Close charge
Discharge	Normal	ON	Flash3	OFF	Indication by SOC						
	Alarm	ON	Flash3	Flash3							
	Under Discharge Protection	ON	OFF	OFF	OFF	OFF	OFF	OFF	OFF	OFF	Close discharge
	Temperature. Over-current. Short Circuit Fault Protection	ON	OFF	ON	OFF	OFF	OFF	OFF	OFF	OFF	Close discharge
Fault		OFF	OFF	ON	OFF	OFF	OFF	OFF	OFF	OFF	Close charge Close discharge

## 6.6 Capacity indication

State		Charge						Discharge					
Capacity indicator light		L6	L5	L4	L3	L2	L1	L6	L5	L4	L3	L2	L1
electricity (%)	0 ~ 17%	OFF	OFF	OFF	OFF	OFF	flash 2	OFF	OFF	OFF	OFF	OFF	ON
	18 ~ 33%	OFF	OFF	OFF	OFF	flash 2	ON	OFF	OFF	OFF	OFF	ON	ON
	34 ~ 50%	OFF	OFF	OFF	flash 2	ON	ON	OFF	OFF	OFF	ON	ON	ON
	51 ~ 66%	OFF	OFF	flash 2	ON	ON	ON	OFF	OFF	ON	ON	ON	ON
	67 ~ 83%	OFF	flash 2	ON	ON	ON	ON	OFF	ON	ON	ON	ON	ON
	84~100%	flash 2	ON	ON	ON	ON	ON	ON	ON	ON	ON	ON	ON
Running light ●		ON						flash(flash 3)					

## 6.7 Light Blink explanation

Flash mode	ON	OFF
Flash 1	0.25S	3.75S
Flash 2	0.5S	0.5S
Flash 3	0.5S	1.5S









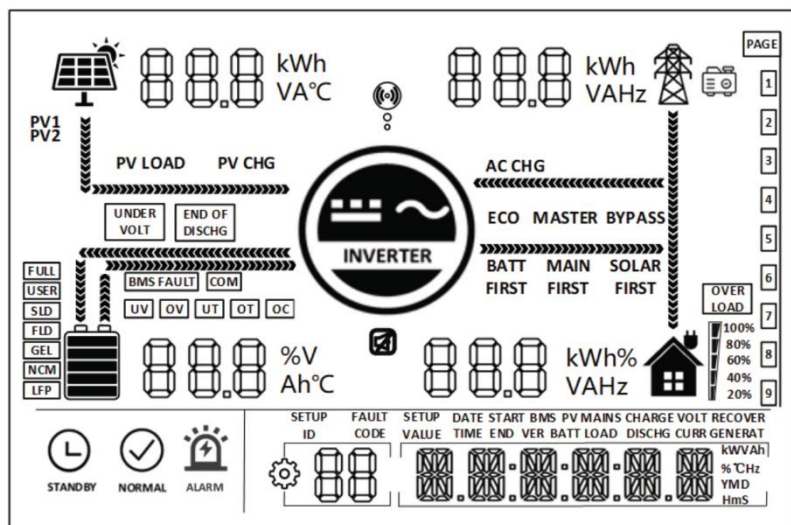

**Note:**













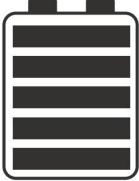









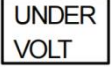
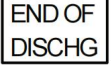
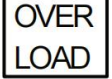

The LED indicator alarm can be enabled or disabled through the host computer. The factory default is enabled.

## 7. Inverter layer

### 7.1 LCD Display Icons

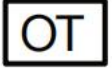
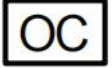
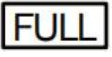
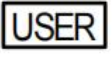
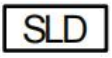
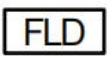

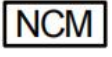
Icon	Description	Icon	Description
	Indicates the PV panel		Indicates the utility grid
	Indicates the direction of energy flow		Indicates the generator
	Indicates the inverter is working		Indicates the home load
	Indicates the inverter is communicating with data collector		Indicates the buzzer muted
 STANDBY	Indicates the inverter is standby	 NORMAL	Indicates the inverter is working normally

 ALARM	Indicates error occur		Indicates setting
	Indicates the battery,  battery SOC 5%~19%;  battery SOC 20%~39%;  battery SOC 40%~59%;  battery SOC 60%~79%;  battery SOC 80%~100%;		Indicating percentage of AC output load,  load power 5%~19% ;  load power 20%~39% ;  load power 40%~59% ;  load power 60%~79% ;  load power 80%~100% ;
	Indicates battery under-voltage		Battery over-discharge
	Indicates over-load		Indicates BMS fault
	Indicates system communication error		Indicates system under-voltage
	Indicates system over-voltage		Indicates system under-temperature
	Indicates system over-temperature		Indicates system over-current
	Indicates battery is full		Indicates user defined battery
	Indicates sealed lead-acid battery		Indicates flooded lead-acid battery
	Indicates gel lead-acid battery		Indicates ternary li-ion battery
	Indicates LFP li-ion battery	<b>ECO</b>	Indicates energy-saving mode
<b>PV LOAD</b>	Indicates PV energy is carrying the load	<b>PV CHG</b>	Indicates PV energy is charging the battery
<b>AC CHG</b>	Indicates AC IN energy is charging the battery	<b>MAIN FIRST</b>	Indicates the inverter output mode is mains power first



<b>BYPASS</b>	Indicates the inverter output mode is bypass	<b>SOLAR FIRST</b>	Indicates the inverter output mode is solar first
<b>BATT FIRST</b>	Indicates the inverter output mode is battery first		

## 7.2 Real-time data view method

In LCD main screen, press keys “UP” and “DOWN” to turn page and view different real time data of the machine.

Page	PV side	BAT side	AC IN side	LOAD side	General
1	PV voltage	Batt Voltage	AC in voltage	Single phase voltage	Current Time
2	PV current	Batt Current	AC in current	Single phase Current	Current Date
3	PV power	Batt Voltage	Total AC charging power	Single phase active power	PV Total kWh
4	PV today kWh	Batt Current	Today AC charging kWh	Single phase apparent power	Load Total kWh
5	PV side heat sink temperature	INV Heat Sink Temperature	AC frequency	AC output frequency	RS485 Address
6	PV rated voltage	Batt Rated Voltage	Busbar voltage	AC output rated power	Software Version
7	Max. PV charging current	Max.Batt charging current	Max. AC charging Current	Total AC output active power	Parallel mode display
8	/	/	/	Total AC output apparent power	/

### 7.3 Setting parameter

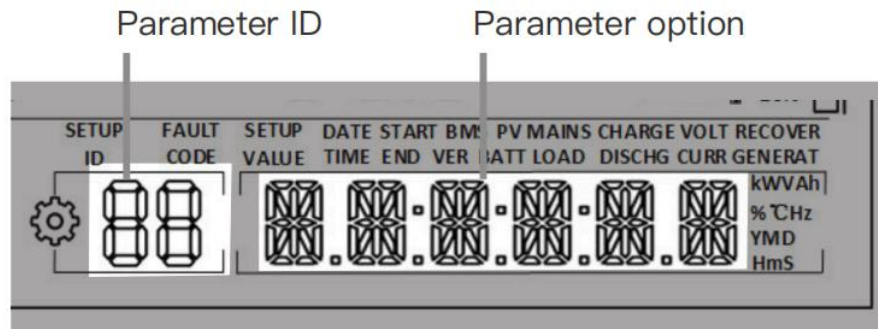
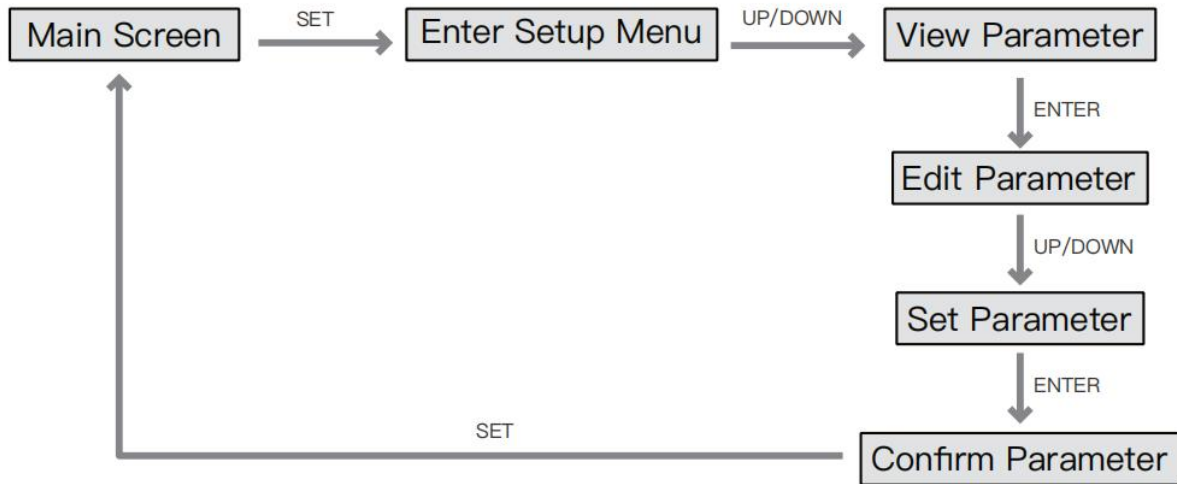

ID	Parameter Meaning	Options	Description
00	Exit	ESC	Exit the setup menu.
01	AC output source priority	UTI <i>default</i>	Utility at first priority, utility and solar provide power to load at the same time when solar is available in both hybrid mode and on-grid mode, battery will provide power to load only when utility power is not available. (When the timed discharge function is used, the battery can be discharged)
		SBU	Inverter at first priority, utility will provide power to load when the battery voltage below parameter [04] value. When the battery voltage is higher than parameter [05] value or when it is full, switching from utility to inverter.
		SOL	Solar at first priority, utility will provide power to load when solar power is not available and the battery voltage below parameter [04] value.
02	AC output frequency	50.0 <i>default</i>	AC output frequency will adaptive utility frequency in bypass mode. Otherwise the output will follow the preset value.
		60.0	

ID	Parameter Meaning	Options	Description
03	AC input voltage range	UPS <i>default</i>	When output range is 220/230V, input voltage range 170~280V.
		RPL	When output range is 220/230V, input voltage range 90~280V, frequency range changes to 40~70 Hz. Can only be set in off-grid mode. Hybrid mode (parameter [34]) automatically changes to ups.
04	Voltage point of battery switch to utility	43.6	When parameter 01 = SBU/SOL, output source will switch to utility from battery when the battery voltage below the preset value. Setting range:40~52V.
05	Voltage point of utility switch to battery	56.8	When parameter 01 = SBU/SOL, output source will switch to battery from utility when the battery voltage above the preset value. Setting range:48~60V.
06	Battery charging mode	SNU <i>default</i>	Solar and utility charging the battery at the same time, solar at the first priority, utility power as a supplement when solar is not sufficient. Solar and utility charging the battery at the same time only in bypass mode, only solar charging can be used when the invert circuit is in operation. Can only be set in off-grid mode. Hybrid mode (parameter [34]) automatically changes to snu.
		CU8	Utility is the first priority in charging, solar charging the battery only when utility is not available.
		CS0	Solar is the first priority in charging, utility charging the battery only when solar is not available.
		DS0	Only solar charging the battery, no utility charging.
07	Battery charging current	60	SPI-8K-SP, setting range:0~180A
			SPI-10K-SP, setting range:0~200A.
08	Battery type	USER	User-defined, user can set all battery parameter.
		SLd	Sealed lead-acid battery.
		FLd	Flooded lead-acid battery.
		GEL <i>default</i>	Gel lead-acid battery.
		L14/L15/L16	LFP li-ion battery, corresponding to batteries 14, 15, 16 series.
N13/N14	Ternary li-ion battery, corresponding to batteries 13, 14 series.		
09	Battery boost charging voltage	57.6	Setting range:48V~58.4V, increment of each click is 0.4V, parameter can be set only when battery type is USER and L14/15/16, N13/14.
10	Battery boost charging delay time	120	This refers to the duration of charging time when the voltage reaches the voltage set in parameter 09 during constant voltage charging, the setting range is 5min~900min, in steps of 5 minutes.
11	Battery float charging voltage	55.2	Setting range: 48V~58.4V, in steps of 0.4V. This parameter cannot be set after successful BMS communication.

ID	Parameter Meaning	Options	Description
12	Battery over-discharge voltage (delay off)	42	When the battery voltage falls below this voltage point and item 13 value is reached, the inverter output will be switched off. Setting range: 40V~48V, in steps of 0.4V.
13	Battery over-discharge voltage delay time	5	When the battery voltage is lower than item 12 of the parameter and the delay time set in this parameter is triggered, the inverter output is switched off, the setting range is 5S~50S, in steps of 5S.
14	Battery under-voltage alarm	44	When the battery voltage falls below this voltage point, alarm will be displayed on the screen and indicator. Setting range: 40V~52V, in steps of 0.4V.
15	Battery under-voltage limit voltage	40	When the battery voltage falls below this voltage point, the inverter output is switched off immediately. Setting range is 40V~52V, in steps of 0.4V, parameter can be set only when battery type is USER and L14/15/16, N13/14.
16	Battery equalization charging	DIS <i>default</i>	Disable equalization charging.
		ENA	Enable equalization charging, parameter can be set only when battery type is FLd/SLd/USER.
17	Battery equalization charging voltage	58	Setting range: 48V~58V, in steps of 0.4V, parameter can be set only when battery type is FLd\SLd\USER.
18	Battery equalization charging duration	120	Setting range: 5min~900min, in steps of 5mins, parameter can be set only when battery type is FLd\SLd\USER.
19	Battery equalization charging delay time	120	Setting range: 5min~900min, in steps of 5mins, parameter can be set only when battery type is FLd\SLd\USER.
20	Battery equalization charging interval	30	Setting range: 0~30 days, in steps of 1day, parameter can be set only when battery type is FLd\SLd\USER.
21	Battery equalization charging stop-start	DIS <i>default</i>	Start equalization charging immediately.
		ENA	Stop equalization charging immediately.
22	Power saving mode (Supports stand-alone mode only)	DIS <i>default</i>	Disable power saving mode.
		ENA	Enable power saving mode, When the load power below 50W, the inverter output will switch off after a 5mins delay . When the load is higher than 50W, the inverter automatic restart.
23	Over-load restart	DIS	When overload occurs and the output is switched off, the machine will not restart.
		ENA <i>default</i>	When overload occurs and the output is switched off, the machine will restart after a delay of 3 mins. After it reaches 5 cumulative time, the machine will not restart automatically.

ID	Parameter Meaning	Options	Description
24	Over-temperature restart	DIS	Disable over-temperature restart. When over temperature occurs and the output is switched off, the machine will not restart.
		ENA <i>default</i>	Enable over-temperature restart. When overload occurs and the output is switched off, the machine will restart when the temperature drops.
25	Buzzer alarm	DIS	Disable buzzer alarm.
		ENA <i>default</i>	Enable buzzer alarm.
26	Power source switching reminder	DIS	Disable reminder when the status of the input power source changes.
		ENA <i>default</i>	Enable reminder when the status of the input power source changes.
27	Inverter overload switch to bypass	DIS	Disable switch to the bypass automatically when the inverter is overload.
		ENA <i>default</i>	Enable switch to the bypass automatically when the inverter is overload.
28	Max. utility charging current	60	SPI-8K-SP, setting range: 0~100A.
			SPI-10K-SP, setting range: 0~120A.
30	RS485 address	1d: 1	RS485 address setting range: 1~254. Parallel mode: 1~6.
31	AC output mode (Settable only in standby mode)	[31] SIG <i>default</i>	Settings for stand-alone use.
		[31] PAR	Settings for single-phase parallel use.
		[31] 3P1/3P2/3P3	Settings for three-phase parallel use.
			All machines in phase 1 must be set as <b>[3P1]</b> , all machines in phase 2 must be set as <b>[3P2]</b> , all machines in phase 3 must be set as <b>[3P3]</b> .  When the output voltage set in the setting <b>[38]</b> is 230Vac: At present, the voltage phase difference between P1-P2, P1-P3 and P2-P3 is 120 degrees. The line voltage between fire wire L1 in phase 1 and fire wire L2 in phase 2 is $230 \times 1.732 = 398\text{Vac}$ , and similarly the line voltage between L1-L3, L2-L3 is 398Vac. The line voltage between L1-N, L2-N, L3-N is 230Vac.
32	RS485 communication	SLA <i>default</i>	Enabling PC and remote monitoring protocols.
		485	Enabling BMS communication based on RS485.
		CAN	Enabling BMS communication based on CAN.
33	BMS communication		When item 32 is set to 485 or CAN, the corresponding communication protocol must be selected in item 33.
			PAC=PACE, RDA=RITAR, AOG=ALLGRAND, OLT=OLITER, HWD=SUNWODA, DAQ=DYNESS, WOW=SRNE, PYL=PYLONTECH, UOL=VILION

ID	Parameter Meaning	Options	Description
34	On-grid and mixed load function	DIS <i>default</i>	Disable this function.
		ON GRD	On-grid function, Solar is charged first and any surplus power after the load demand is met is fed back to the grid. (Item 01 is set to UTI, item 03 is set to UPS, item 06 is set to SNU)
		MIX LOD	Mixed load mode, solar is used in priority to charge the battery and any excess energy is used to power the load when available. With backflow preventer function, solar power is not fed back to the grid. (Item 01 is set to UTI, item 03 is set to UPS, item 06 is set to SNU)
35	Battery under voltage recover point	52	When the battery is under-voltage, the battery voltage needs to be greater than this setting to restore the battery inverter AC output. Setting range: 44V~54.4V.
37	Battery full recharge voltage point	52	Inverter stops charging when the battery is full. Inverter resumes charging when the battery voltage below this value. Setting range: 44V~54V.
38	AC output voltage	220	Setting range: 200/208/220/230/240Vac
39	Charge current limit method (when BMS is enabled)	LC SET	Max. battery charging current not greater than the value of setting [07]
		LC BMS <i>default</i>	Max. battery charging current not greater than the limit value of BMS
		LC INV	Max. battery charging current not greater than the logic judgements value of the inverter
40	1st slot start charging	00:00:00	Setting range: 00:00:00~23:59:00
41	1st slot end charging	00:00:00	Setting range: 00:00:00~23:59:00
42	2nd slot start charging	00:00:00	Setting range: 00:00:00~23:59:00
43	2nd slot end charging	00:00:00	Setting range: 00:00:00~23:59:00
44	3rd slot start charging	00:00:00	Setting range: 00:00:00~23:59:00
45	3rd slot end charging	00:00:00	Setting range: 00:00:00~23:59:00
46	Time slot charging function	DIS <i>default</i>	Disable this function.
		ENR	Enable this function, AC output source mode will switch to SBU, utility charging the battery and carry load only in charging time slot which user set or the battery is under voltage. If time slot discharging function is also enabled, AC output source mode will switch to UTI, utility charging the battery only in charging time slot which user set, and switch to battery charging in discharging time slot or utility power failure. (pure off-grid mode only)
47	1st slot start discharging	00:00:00	Setting range: 00:00:00~23:59:00
48	1st slot end discharging	00:00:00	Setting range: 00:00:00~23:59:00
49	2nd slot start discharging	00:00:00	Setting range: 00:00:00~23:59:00
50	2nd slot end discharging	00:00:00	Setting range: 00:00:00~23:59:00
51	3rd slot start discharging	00:00:00	Setting range: 00:00:00~23:59:00

ID	Parameter Meaning	Options	Description
52	3rd slot end discharging	DIS <i>default</i>	Setting range: 00:00:00–23:59:00
53	Time slot discharging function	ENA	Disable this function.
			Enable this function, AC output source mode will switch to UTI , battery discharging only in discharging time slot which user set or utility is not available.
54	Local date	00:00:00	YY/MM/DD. Setting range: 00:01:01–99:12:31
55	Local time	00:00:00	Setting range: 00:00:00–23:59:59
57	Stop charging current	2	Charging stops when the charging current is less than the set value. (unit:A)
58	Discharging alarm SOC	15	Triggers an alarm when the battery SOC is less than the set value. (unit:%)
59	Discharging cutoff SOC	5	Stops discharging when the battery SOC is less than the set value. (unit:%)
60	Charging cutoff SOC	100	Stops charging when the battery SOC is higher than the set value. (unit:%)
61	Switching to utility SOC	10	Switch to utility power when the battery SOC is less than this setting. (unit:%)
62	Switching to inverter SOC	100 <i>default</i>	Switches to inverter output mode when SOC is higher than this setting. (unit:%)
63	N-PE bonding automatic switching function	DIS <i>default</i>	Prohibit automatic switching of N-PE bonding.
		ENA	Allow automatic switching of N-PE bonding.
71	PV energy priority	CHG	PV energy gives priority to battery charging, then on-grid charging.
		100	PV energy is prioritized for grid generation.

## 7.4 AC Output Mode

The AC output mode corresponds to parameter setting item 01 and 34, which allows the user to set the AC output power source manually.

### ➤ Utility Priority Output 01 UTI (default):

Utility at first priority, utility and solar provide power to load at the same time when solar is available, battery will provide power to load only when utility power is not available.(Priority: utility>solar>battery.)

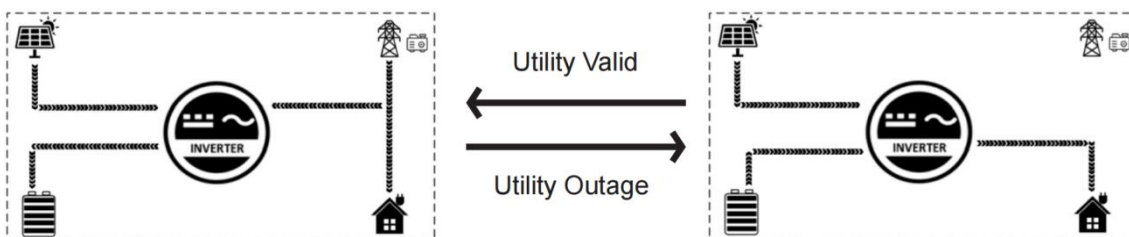

### ➤ Solar and Utility Hybrid Output 34 MIX LOd:

In UTI mode, when not connected to the battery or when the battery is full, the solar and the utility supply power to the load at the same time.(Priority: solar>utility>battery.)

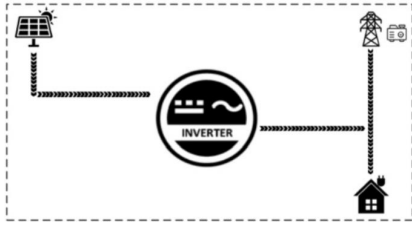

Battery disconnected

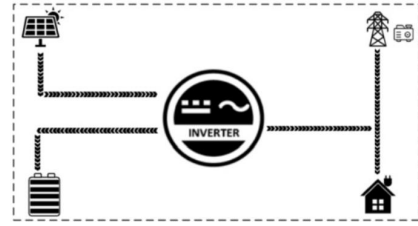

Battery Full

➤ **Solar Priority Output 01 50L :**

Solar provides power to the loads as first priority. If solar is not available, the utility grid will provide power to the loads. This mode maximizes solar energy while maintaining battery power and is suitable for areas with relatively stable power grids. (Priority: solar>utility>battery.)

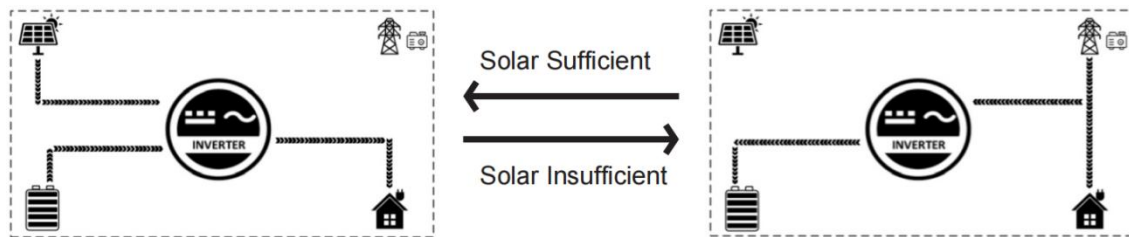

➤ **Inverter Priority Output 01 56J :**

Solar provides power to the loads as first priority. If solar is not sufficient or not available, the battery will be used as a supplement to provide power to the loads. When the battery voltage reaches the value of parameter 04 (Voltage point of battery switch to utility) will switch to utility to provide power to the load. This model makes maximum use of DC energy and is used in areas where the grid is stable. (Priority: solar>battery>utility.)

**7.5 Battery Charging Mode**

The charging mode corresponds to parameter setting item 06, which allows the user to set the charging mode manually.

➤ **Hybrid Charging 5NU (default):**

Solar and utility charging the battery at the same time, solar at the first priority, utility power as a supplement when solar power is not sufficient. This is the fastest way to charge and is suitable for areas with low power supply, providing customers with sufficient back-up power. (Source priority: solar>utility.)

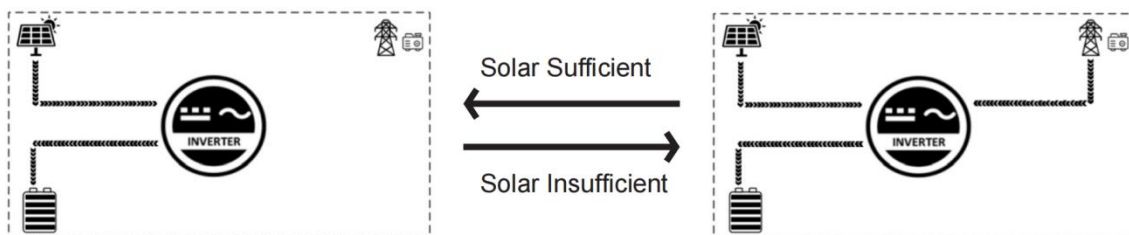

➤ **Utility Priority Charging 02B :**

The utility power gives priority to charging the battery, and PV charging is only activated when the utility power is not available. (Source priority: utility>solar.)



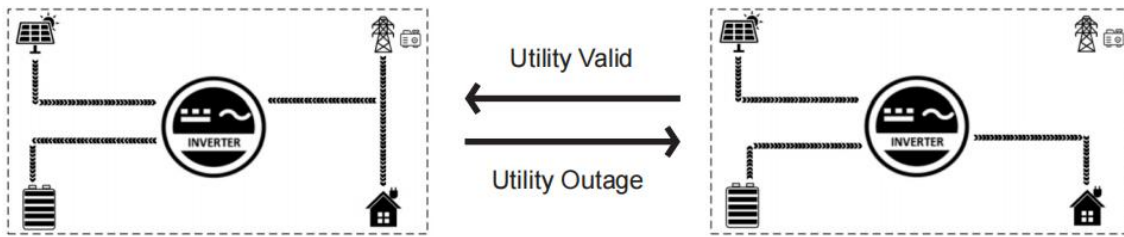

➤ **Solar Priority Charging 050 :**

Solar priority charging, with utility charging only activated when the solar fails. By making full use of solar power during the day and switching to utility charging at night, battery power can be maintained and is suitable for applications in areas where the arid is relatively stable and electricity prices are more expensive. Source priority: solar>utility.)

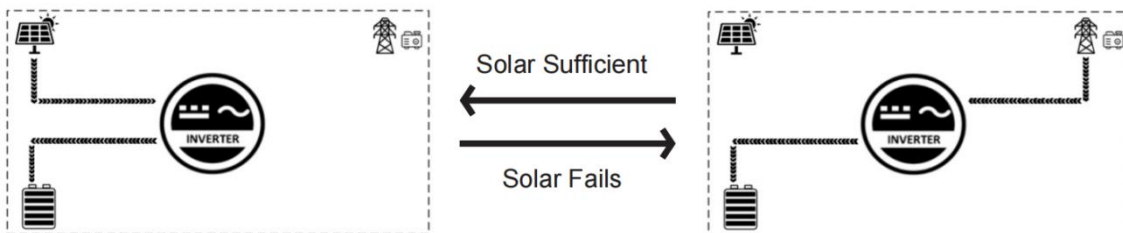

➤ **Only Solar Charging 050 :**

Solar charging only, no mains charging is activated. This is the most energy-efficient method, with all the battery power coming from solar energy, and is usually used in areas with good radiation conditions.

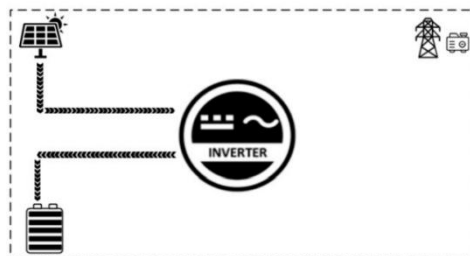

**7.6 Fault Reference Code**

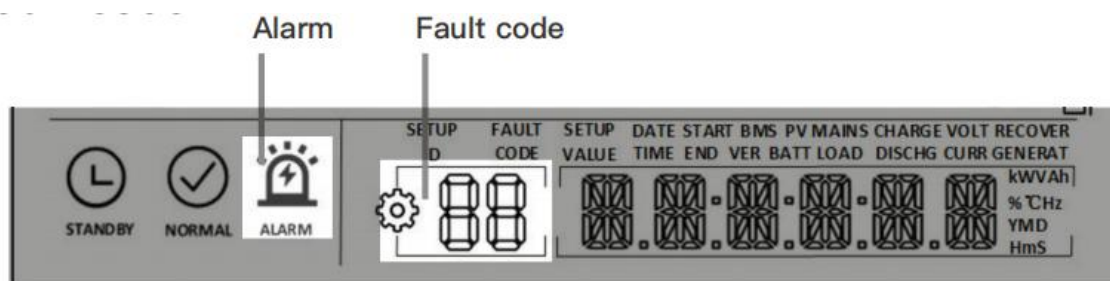

Fault Code	Fault Name	Affecting output or not	Note
------------	------------	-------------------------	------

<b>【01】</b>	BatVoltLow	Yes	Battery under-voltage alarm
<b>【02】</b>	BatOverCurrSw	Yes	Average over-current software protection for battery discharge
<b>【03】</b>	BatOpen	Yes	No connection alarm of battery
<b>【04】</b>	BatLowEod	Yes	Stop discharge alarm for battery under voltage
<b>【05】</b>	BatOverCurrHw	Yes	Battery over-current hardware protection
<b>【06】</b>	BatOverVolt	Yes	Charge over-voltage protection
<b>【07】</b>	BusOverVoltHw	Yes	Bus over-voltage hardware protection
<b>【08】</b>	BusOverVoltSw	Yes	Bus over-voltage software protection
<b>【09】</b>	PV VoltHigh	Yes	PV over-voltage protection
<b>【10】</b>	PVBoostOCSw	No	Boost circuit over-current software protection
<b>【11】</b>	PVBoost OCHw	No	Boost circuit over-current hardware protection
<b>【12】</b>	SpiCommErr	Yes	Master-slave chip SP 1 communication failure
<b>【13】</b>	OverloadBypass	Yes	Bypass overload protection
<b>【14】</b>	OverloadInverter	Yes	Inverter overload protection
<b>【15】</b>	AcOverCurrHw	Yes	Inverter over-current hardware protection
<b>【16】</b>	AuxDspReqOffP WM	Yes	Slave chip request switch off failure
<b>【17】</b>	InvShort	Yes	Inverter short-circuit protection

<b>【19】</b>	OverTemperMppt	No	PV radiator over temperature protection
<b>【20】</b>	OverTemperInv	Yes	Over temperature protection of inverter radiator
<b>【21】</b>	FanFail	Yes	Fan fault
<b>【22】</b>	EEPROM	Yes	Memory fault
<b>【23】</b>	ModelNumErr	Yes	Inaccurate model setting
<b>【24】</b>	Busdiff	Yes	Bus bar voltage imbalance
<b>【25】</b>	BusShort	Yes	Bus bar short circuit
<b>【26】</b>	RlyShort	Yes	Inverter output back flow to bypass
<b>【28】</b>	LinePhaseErr	Yes	Utility input phase fault
<b>【29】</b>	BusVoltLow	Yes	Bus under-voltage protection
<b>【30】</b>	BatCapacityLow1	No	Battery SOC below 10% alarm (valid when BMS is enabled)
<b>【31】</b>	BatCapacityLow2	No	Battery SOC below 5% alarm (valid when BMS is enabled)
<b>【32】</b>	BatCapacityLowS top	Yes	Battery low capacity shutdown (valid when BMS is enabled)
<b>【33】</b>	CtrlCanCommErr	Yes	Parallel control can communication fault
<b>【34】</b>	CanCommFault	Yes	Parallel can communication fault
<b>【35】</b>	ParaAddrErr	Yes	Parallel ID(communication address) is incorrectly
<b>【37】</b>	ParaShareCurrErr	Yes	Parallel flow equalisation fault

<b>【38】</b>	ParaBattVoltDiff	Yes	Parallel mode, large differences in battery voltage
<b>【39】</b>	ParaAcSrcDiff	Yes	Parallel mode, inconsistent mains input source
<b>【40】</b>	ParaHwSynErr	Yes	Parallel mode, hardware sync signal failure
<b>【41】</b>	InvDcVoltErr	Yes	DC component of the inverter voltage is abnormal
<b>【42】</b>	SysFwVersionDiff	Yes	Inconsistent parallel program versions
<b>【43】</b>	ParaLineContErr	Yes	Parallel wiring fault
<b>【44】</b>	Serial number error	Yes	No serial number set at factory
<b>【45】</b>	Phase merging unitconfigured incorrectly	Yes	Item [31] is wrongly set
<b>【58】</b>	BMS com err	No	BMS communication failure
<b>【59】</b>	BMSErr	No	BMS failures occur
<b>【60】</b>	BMSUnderTem	No	BMS under-temperature alarm(Only enable BMS take effect)
<b>【61】</b>	BMSOverTem	No	BMS over-temperature alarm (Only enable BMS take effect)
<b>【62】</b>	BMSOverCur	No	BMS over-current alarm(Only enable BMS take effect)
<b>【63】</b>	BMSUnderVolt	No	BMS under-voltage alarm(Only enable BMS take effect)
<b>【64】</b>	BMSover-volt	No	BMS over-voltage alarm (Only enable BMS take effect)

## 8. Emergency Situations

### 8.1 Battery Leakage

If the battery pack leaks electrolyte, avoid contact with the leaking liquid or gas. If one is exposed to the leaked substance, immediately perform the actions described below.

- 1) Inhalation: Evacuate contaminated area and seek medical aid.
- 2) Contact with eyes: Rinse eyes with flowing water for 15 minutes and seek medical aid.
- 3) Contact with skin: Wash affected area thoroughly with soap water and seek medical aid.
- 4) Ingestion: Induce vomiting and seek medical aid.

### 8.2 On Fire



**NO WATER!**

Only dry powder fire or carbon dioxide extinguisher can be used; if possible, move the battery module to a safe area before it catches fire.

### 8.3 Wet Batteries

If the module is wet or submerged in water, do not let people access it, then contact us or an authorized dealer for technical support. Cut off all power switch on inverter side.

### 8.4 Damaged Batteries

Damaged batteries are dangerous and must be handled with utmost care. They are not fit for use and may pose a danger to people or property. If the module seems to be damaged, pack it in its original container, then return it to authorized dealer.



**Warning**

Damaged batteries may leak electrolyte or produce flammable gas.

## 9. Remarks

### 9.1 Recycle and Disposal

In case a battery (normal condition or damaged) needs disposal or needs recycling, it shall follow the local recycling regulation (Suggest Regulation (EC) N° 1013/2006 among European Union) to process, and using the best available techniques to achieve a relevant recycling efficiency.



### 9.2 Maintenance

Check installation environment such as dust, water, insect etc. Make sure it is suitable for IP20 battery system. Connection of power connector, grounding point, power cable and screw are suggested to be checked every year.

## Parts List

Item	Part Name	Description	Unit	Quantity
1	Battery layer	Optional up to 4floors	PCS	1-4
2	Communication cable	RJ45network cable0.5m	PCS	Same as the number of batteries
3	Inverter		PCS	1
4	Base		PCS	1
5	Hexagon screw	M6*10	PCS	Twice the number of modules
6				
7				
8				

## Maintenance Record

Dear user.thank you for selecting our product,Please fill in and keep the warranty card for better services.

Attn:\_\_\_\_\_Product No:\_\_\_\_\_

Tel:\_\_\_\_\_E-mail:\_\_\_\_\_

Purchase Date:\_\_\_\_\_

Address:\_\_\_\_\_

Maintenance Record			
Date of repair	Content	Maintenance Personnel	Note



## Suzhou Preta Intelligence and Technology Co.,Ltd

---

Add: No..55 Shangxiang Road, Huaqiao Corporation Head Quarter Centre, Kunshan City, Suzhou City, China

Tel: 0512-36684019

Email: [info@pretapower.com](mailto:info@pretapower.com)

Web: <https://pretapower.com/>