



USER MANUAL

2.2KVA/3.2KVA
INVERTER / MPPT SCC / AC CHARGER

Table Of Contents

1	ABOUT THIS MANUAL	3
1.1	PURPOSE.....	3
1.2	SCOPE.....	3
2	SAFETY INSTRUCTIONS	3
3	INTRODUCTION	4
3.1	FEATURES.....	4
3.2	BASIC SYSTEM ARCHITECTURE.....	4
3.3	PRODUCT OVERVIEW.....	5
4	INSTALLATION	6
4.1	UNPACKING AND INSPECTION.....	6
4.2	PREPARATION.....	6
4.3	MOUNTING THE UNIT	6
4.4	BATTERY CONNECTION.....	7
4.5	AC INPUT/OUTPUT CONNECTION	8
4.6	PV CONNECTION.....	9
4.7	FINAL ASSEMBLY	10
5	OPERATION	10
5.1	POWER ON/OFF	10
5.2	OPERATION AND DISPLAY PANEL	10
5.3	LCD DISPLAY ICONS	11
5.4	LCD SETTING	13
5.5	DISPLAY SETTING.....	20
5.6	OPERATING MODE DESCRIPTION.....	23
5.7	BATTERY EQUALIZATION DESCRIPTION.....	24
5.8	FAULT REFERENCE CODE.....	26
5.9	WARNING INDICATOR.....	26
6	CLEARANCE AND MAINTENANCE FOR ANTI-DUST KIT	27
6.1	OVERVIEW.....	27
6.2	CLEARANCE AND MAINTENANCE	27
7	INSTRUCTIONS FOR HOW TO ENTER THE DISPLAY INTERFACE FOR LITHIUM BATTERY AND TURN THE INTERFACE	28
8	SPECIFICATIONS	31
	TABLE 1 LINE MODE SPECIFICATIONS	31
	TABLE 2 INVERTER MODE SPECIFICATIONS	32
	TABLE 3 CHARGE MODE SPECIFICATIONS.....	32
	TABLE 4 GENERAL SPECIFICATIONS.....	33
9	TROUBLE SHOOTING	34

1 ABOUT THIS MANUAL

1.1 Purpose

This manual describes the assembly, installation, operation and troubleshooting of this unit. Please read this manual carefully before installations and operations. Keep this manual for future reference.

1.2 Scope

This manual provides safety and installation guidelines as well as information on tools and wiring.

2 SAFETY INSTRUCTIONS



WARNING: This chapter contains important safety and operating instructions. Read and keep this manual for future reference.

1. Before using the unit, read all instructions and cautionary markings on the unit, the batteries and all appropriate sections of this manual.
2. **CAUTION** --To reduce risk of injury, charge only deep-cycle lead acid type rechargeable batteries. Other types of batteries may burst, causing personal injury and damage.
3. Do not disassemble the unit. Take it to a qualified service center when service or repair is required. Incorrect re-assembly may result in a risk of electric shock or fire.
4. To reduce risk of electric shock, disconnect all wirings before attempting any maintenance or cleaning. Turning off the unit will not reduce this risk.
5. **CAUTION** – Only qualified personnel can install this device with battery.
6. **NEVER** charge a frozen battery.
7. For optimum operation of this inverter/charger, please follow required spec to select appropriate cable size. It's very important to correctly operate this inverter/charger.
8. Be very cautious when working with metal tools on or around batteries. A potential risk exists to drop a tool to spark or short circuit batteries or other electrical parts and could cause an explosion.
9. Please strictly follow installation procedure when you want to disconnect AC or DC terminals. Please refer to INSTALLATION section of this manual for the details.
10. **GROUNDING INSTRUCTIONS** -This inverter/charger should be connected to a permanent grounded wiring system. Be sure to comply with local requirements and regulation to install this inverter.
11. **NEVER** cause AC output and DC input short circuited. Do NOT connect to the mains when DC input short circuits.
12. **Warning!!** Only qualified service persons are able to service this device. If errors still persist after following troubleshooting table, please send this inverter/charger back to local dealer or service center for maintenance.

3 INTRODUCTION

This is a multi-function inverter/charger, combining functions of inverter, solar charger and battery charger to offer uninterruptible power support with portable size. Its comprehensive LCD display offers user-configurable and easy-accessible button operation such as battery charging current, AC/solar charger priority, and acceptable input voltage based on different applications.

3.1 Features

- Pure sine wave inverter
- Configurable input voltage range for home appliances and personal computers via LCD setting
- Configurable battery charging current based on applications via LCD setting
- Configurable AC/Solar Charger priority via LCD setting
- Compatible to mains voltage or generator power
- Auto restart while AC is recovering
- Overload/ Over temperature/ short circuit protection
- Smart battery charger design for optimized battery performance
- Cold start function
- WIFI(Optional)
- Can connect to lithium battery
- Intelligent fan speed adjustment

3.2 Basic System Architecture

The following illustration shows basic application for this inverter/charger. It also includes following devices to have a complete running system:

- Generator or Utility.
- PV modules

Consult with your system integrator for other possible system architectures depending on your requirements.

This inverter can power all kinds of appliances in home or office environment, including motor-type appliances such as tube light, fan, refrigerator and air conditioner.

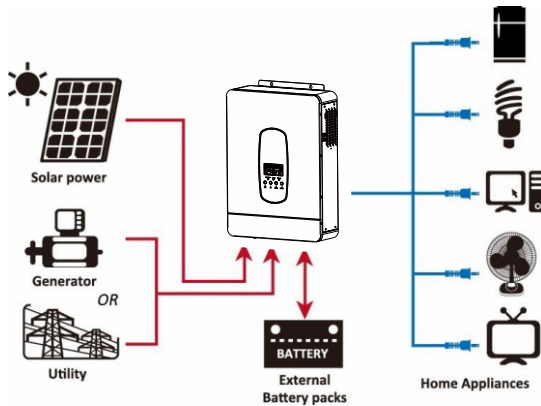
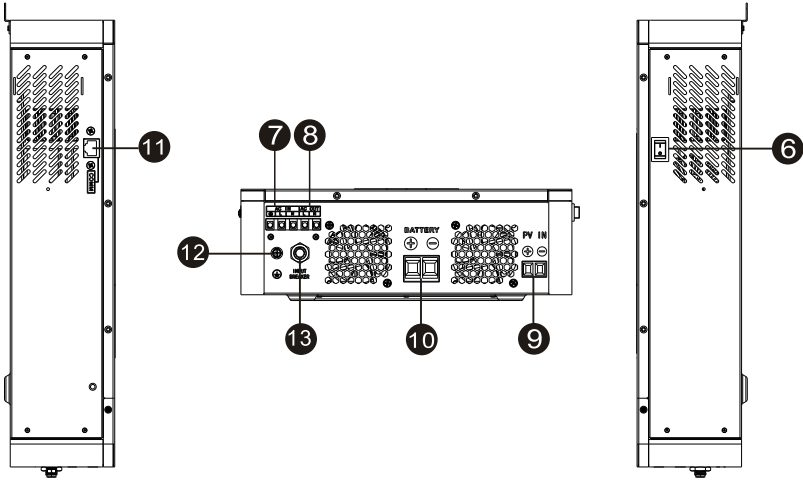
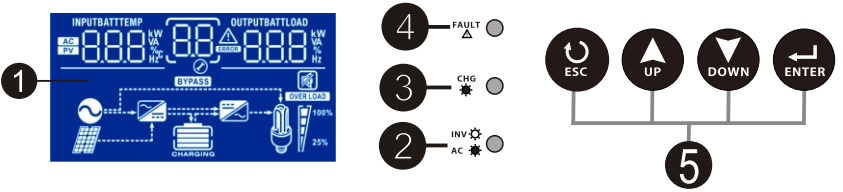

Figure 1 Hybrid Power System

3.3 Product Overview



1. LCD display
2. Status indicator
3. Charging indicator
4. Fault indicator
5. Function buttons
6. Power on/off switch
7. AC input
8. AC output
9. PV input
10. Battery input
11. RS-232 communication port
12. Safety(Earth)ground
13. Circuit breaker

4 INSTALLATION

4.1 Unpacking and Inspection

Before installation, please inspect the unit. Be sure that nothing inside the package is damaged. You should have received the following items inside of package:

- The unit x 1
- User manual x 1

4.2 Preparation

Before connecting all wirings, please take off bottom cover by removing two screws as shown below.

4.3 Mounting the Unit

Consider the following points before selecting where to install:

- Do not mount the inverter on flammable construction materials.
- Mount on a solid surface
- Install this inverter at eye level in order to allow the LCD display to be read at all times.
- For proper air circulation to dissipate heat, allow a clearance of approx. 20 cm to the side and approx. 50 cm above and below the unit.
- The ambient temperature should be between 0°C and 55°C to ensure optimal operation.
- The recommended installation position is to be adhered to the wall vertically.
- Be sure to keep other objects and surfaces as shown in the diagram to guarantee sufficient heat dissipation and to have enough space for removing wires.

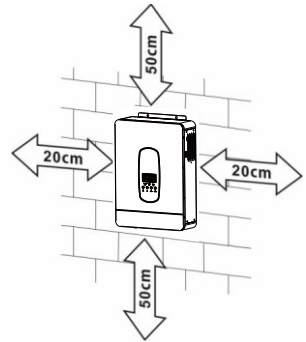

! SUITABLE FOR MOUNTING ON CONCRETE OR OTHER NON-COMBUSTIBLE SURFACE ONLY.

Install the unit by screwing two screws. It's recommended to use M4 or M5 screws.

4.4 Battery Connection

CAUTION: For safety operation and regulation compliance, it's requested to install a separate DC over-current protector or disconnect device between battery and inverter. It may not be requested to have a disconnect device in some applications, however, it's still requested to have over-current protection installed. Please refer to typical amperage in below table as required fuse or breaker size.

WARNING! All wiring must be performed by a qualified personnel.
WARNING! It's very important for system safety and efficient operation to use appropriate cable for battery connection. To reduce risk of injury, please use the proper recommended cable as below.

Recommended battery cable size:

Model	Wire Size	Cable (mm ²)	Torque value (max)
2.2KVA 12V	1 x 4AWG	22	2 Nm
3.2KVA 24V	1 x 6AWG	14	2 Nm

Please follow below steps to implement battery connection:

1. Remove insulation sleeve 18 mm for positive and negative conductors.
2. Suggest to put bootlace ferrules on the end of positive and negative wires with a proper crimping tool.

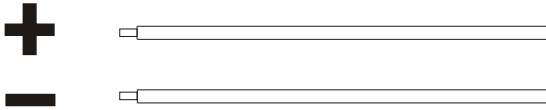

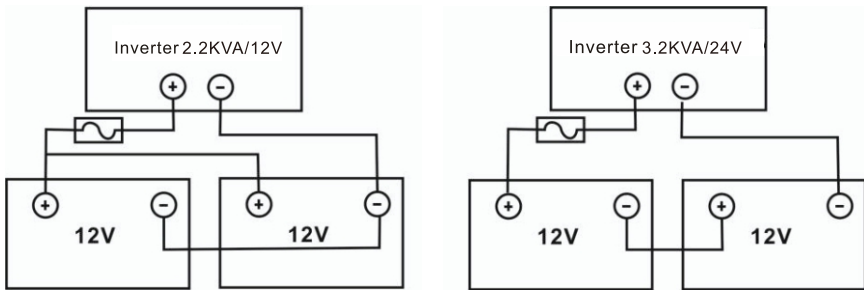

4. Connect all battery packs as below chart.

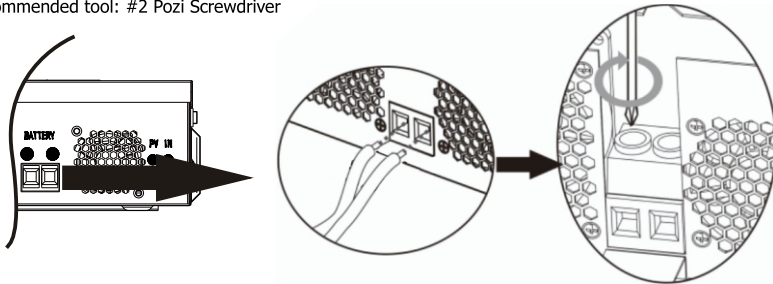

5. Insert the battery wires flatly into battery connectors of inverter and make sure the bolts are tightened with torque of 2 Nm in clockwise direction. Make sure polarity at both the battery and the inverter/charge is correctly connected and conductors are tightly screwed into the battery terminals.

Recommended tool: #2 Pozzi Screwdriver



 **WARNING: Shock Hazard**
Installation must be performed with care due to high battery voltage in series.

 **CAUTION!!** Before making the final DC connection or closing DC breaker/disconnector, be sure positive (+) must be connected to positive (+) and negative (-) must be connected to negative (-).

4.5 AC Input /Output Connection

CAUTION!! Before connecting to AC input power source, please install a **separate** AC breaker between inverter and AC input power source. This will ensure the inverter can be securely disconnected during maintenance and fully protected from over current of AC input. The recommended spec of AC breaker is 20A for 2.2kva and 32A for 3.2kva.

CAUTION!! There are two terminal blocks with "IN" and "OUT" markings. Please do NOT mis-connect input and output connectors.

WARNING! All wiring must be performed by a qualified personnel.

WARNING! It's very important for system safety and efficient operation to use appropriate cable for AC input connection. To reduce risk of injury, please use the proper recommended cable size as below.

Suggested cable requirement for AC wires

Model	Gauge	Torque Value
2.2KVA 12V	14 AWG	0.5~0.6Nm
3.2KVA 24V	12 AWG	1.2 Nm

Please follow below steps to implement AC input/output connection:

1. Before making AC input/output connection, be sure to open DC protector or disconnecter first.
2. Remove insulation sleeve 10mm for five conductors. And shorten phase L and neutral conductor N 3 mm.
3. Insert AC input wires according to polarities indicated on terminal block and tighten the terminal screws. Be sure to connect PE protective conductor (⊕) first.

- ⊕ → **Ground (yellow-green)**
- L → **LINE (brown or black)**
- N → **Neutral (blue)**

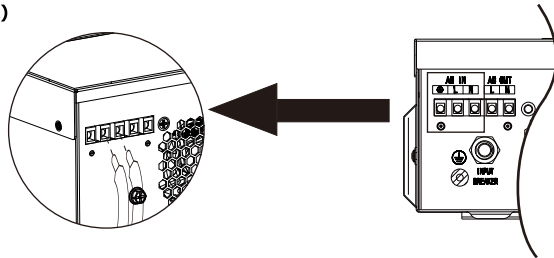

	<p>WARNING: Be sure that AC power source is disconnected before attempting to hardwire it to the unit.</p>
--	---

4. Then, insert AC output wires according to polarities indicated on terminal block and tighten terminal screws.

- L → **LINE (brown or black)**
- N → **Neutral (blue)**

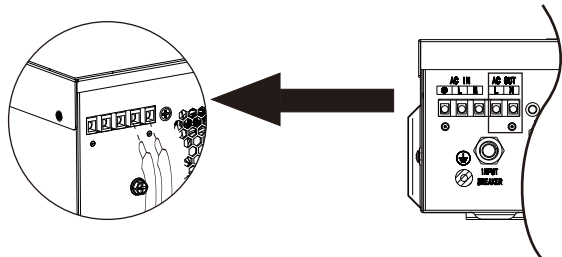

5. Make sure the wires are securely connected.

CAUTION: Appliances such as air conditioner are required at least 2~3 minutes to restart because it' serquired to have enough time to balance refrigerant gas inside of circuits. If a power shortage occurs and recovers in a short time, it will cause damage to your connected appliances. To prevent this kind of damage, please check manufacturer of air conditioner if it's equipped with time-delay function before installation. Otherwise, this inverter/charger will trig overload fault and cut off output to protect your appliance but sometimes it still causes internal damage to the air conditioner.

4.6 PV Connection

CAUTION: Before connecting to PV modules, please install **separately** a DC circuit breaker between inverter and PV modules.

WARNING! It's very important for system safety and efficient operation to use appropriate cable for PV module connection. To reduce risk of injury, please use the proper recommended cable size as below.

Model	Wire Size	Torque value (max)
2.2KVA 12V 3.2KVA 24V	1x16AWG	1.2 Nm

PV Module Selection:

When selecting proper PV modules, please be sure to consider below parameters:

1. Open circuit Voltage (Voc) of PV modules not exceeds max. PV array open circuit voltage of inverter.

INVERTER MODEL	2.2KVA/3.2KVA
Max. PV Array Open Circuit Voltage	450Vdc
PV Array MPPT Voltage Range	55Vdc~430Vdc

Take 250Wp PV module as an example. After considering above two parameters, the recommended module configurations are listed as below table.

Solar Panel Spec. (reference)	SOLAR INPUT		Q'ty of panels	Total input power
	(Min in serial: 4 pcs, max. in serial: 12 pcs)			
- 250Wp				
- Vmp: 30.1Vdc	4 pcs in serial		4 pcs	1000W
- Imp: 8.3A	6 pcs in serial		6 pcs	1500W
- Voc: 37.7Vdc	8 pcs in serial		8 pcs	2000W
- Isc: 8.4A	12 pcs in serial		12 pcs	3000W
- Cells: 60				

PV Module Wire Connection

Please follow below steps to implement PV module connection:

1. Remove insulation sleeve 10 mm for positive and negative conductors.
2. Suggest to put bootlace ferrules on the end of positive and negative wires with a proper crimping tool.

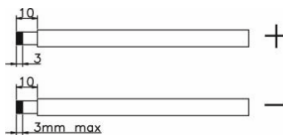

4. Check correct polarity of wire connection from PV modules and PV input connectors. Then, connect positive pole (+) of connection wire to positive pole (+) of PV input connector. Connect negative pole (-) of connection wire to negative pole (-) of PV input connector.
Recommended tool: 4mm blade screwdriver

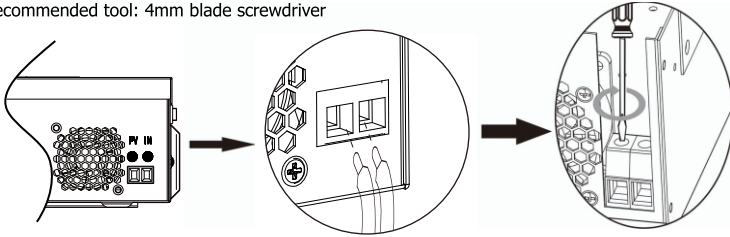

4.7 Final Assembly

After connecting all wirings, please put bottom cover back by screwing four screws as shown below.

5 OPERATION

5.1 Power ON/OFF

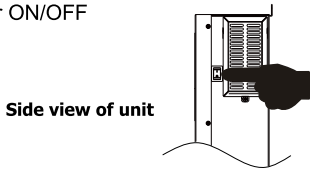

Side view of unit

Once the unit has been properly installed and the batteries are connected well, simply press On/Off switch (located on the button of the case) to turn on the unit.

5.2 Operation and Display Panel

The operation and display panel, shown in below chart, is on the front panel of the inverter. It includes three indicators, four function keys and a LCD display, indicating the operating status and input/output power information.



LCD display

Function keys

LED Indicator

LED Indicator		Messages	
☀ AC / ☀ INV	Green	Solid On	Output is powered by utility in Line mode.
		Flashing	Output is powered by battery or PV in battery mode.
☀ CHG	Green	Solid On	Battery is fully charged.
		Flashing	Battery is charging.
⚠ FAULT	Red	Solid On	Fault occurs in the inverter.
		Flashing	Warning condition occurs in the inverter.







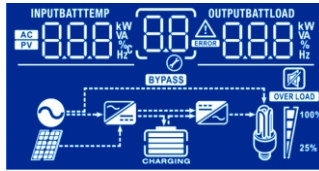









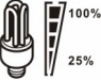

Function Keys

Function Key	Description
ESC	To exit setting mode
UP	To go to previous selection
DOWN	To go to next selection
ENTER	To confirm the selection in setting mode or enter setting mode

5.3 LCD Display Icons



Icon	Function description	
Input Source Information		
	Indicates the AC input.	
	Indicates the PV input	
	Indicate input voltage, input frequency, PV voltage, charger current (if PV in charging for 2.2KVA models), charger power, battery voltage.	
Configuration Program and Fault Information		
	Indicates the setting programs.	
	Indicates the warning and fault codes.	
Warning:	flashing with warning code.	
Fault:	lighting with fault code	
Output Information		
	Indicate output voltage, output frequency, load percent, load in VA, load in Watt and discharging current.	
Battery Information		
	Indicates battery level by 0-24%, 25-49%, 50-74% and 75-100% in battery mode and charging status in line mode.	
In AC mode, it will present battery charging status.		
Status	Battery voltage	LCD Display
Constant Current mode / Constant Voltage mode	<2V/cell	4 bars will flash in turns.
	2 ~ 2.083V/cell	Bottom bar will be on and the other three bars will flash in turns.
	2.083 ~ 2.167V/cell	Bottom two bars will be on and the other two bars will flash in turns.
	> 2.167 V/cell	Bottom three bars will be on and the top bar will flash.
Floating mode. Batteries are fully charged.		4 bars will be on.

In battery mode, it will present battery capacity.				
Load Percentage	Battery Voltage		LCD Display	
Load >50%	< 1.85V/cell			
	1.85V/cell ~ 1.933V/cell			
	1.933V/cell ~ 2.017V/cell			
	> 2.017V/cell			
Load < 50%	< 1.892V/cell			
	1.892V/cell ~ 1.975V/cell			
	1.975V/cell ~ 2.058V/cell			
	> 2.058V/cell			
Load Information				
	Indicates overload.			
	Indicates the load level by 0-24%, 25-49%, 50-74% and 75-100%.			
	0%~24%	25%~49%	50%~74%	75%~100%
				
Mode Operation Information				
	Indicates unit connects to the mains.			
	Indicates unit connects to the PV panel.			
	Indicates load is supplied by utility power.			
	Indicates the utility charger circuit is working.			
	Indicates the DC/AC inverter circuit is working.			
Mute Operation				
	Indicates unit alarm is disabled.			

5.4 LCD Setting





















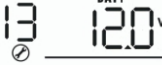

After pressing and holding ENTER button for 3 seconds, the unit will enter setting mode. Press "UP" or "DOWN" button to select setting programs. And then, press "ENTER" button to confirm the selection or ESC button to exit.

Setting Programs:



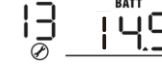

Program	Description	Selectable option	
00	Exit setting mode	Escape 00 ESC	
01	Output source priority: To configure load power source priority	SUB priority (default) 01 SUB	Solar energy provides power to the loads as first priority. If solar energy is not sufficient to power all connected loads, utility will supply power to the loads at the same time. Battery provides power to the loads only when any one condition happens: - Solar energy and utility is not available. - Solar energy is not sufficient and utility is not available.
		SBU priority 01 SBU	Solar energy provides power to the loads as first priority. If solar energy is not sufficient to power all connected loads, battery energy will supply power to the loads at the same time. Utility provides power to the loads only when battery voltage drops to either low-level warning voltage or the setting point in program 12.
02	Maximum charging current: To configure total charging current for solar and utility chargers. (Max. charging current = utility charging current + solar charging current)	10A 02 10 A	20A 02 20 A
		30A 02 30 A	40A 02 40 A
		50A 02 50 A	60A (default) 02 60 A
		70A 02 70 A	80A 02 80 A

03	AC input voltage range	Appliances (default) 03 APL	If selected, acceptable AC input voltage range will be within 90-280VAC.
		UPS 03 UPS	If selected, acceptable AC input voltage range will be within 170-280VAC.
04	Power saving mode enable/disable	Saving mode disable (default) 04 SDS	If disabled, no matter connected load is low or high, the on/off status of inverter output will not be effected.
		Saving mode enable 04 SEN	If enabled, the output of inverter will be off when connected load is pretty low or not detected.
05	Battery type	AGM (default) 05 AGM	Flooded 05 FLD
		User-Defined 05 USE	If "User-Defined" is selected, battery charge voltage and low DC cut-off voltage can be set up in program 26, 27 and 29.
06	Auto restart when overload occurs	Restart disable (default) 06 LFD	Restart enable 06 LFE
07	Auto restart when over temperature occurs	Restart disable (default) 07 tFd	Restart enable 07 tFE
08	Output voltage	220V 08 220 ^v	230V (default) 08 230 ^v
		240V 08 240 ^v	
09	Output frequency	50Hz (default) 09 50 _{Hz}	60Hz 09 60 _{Hz}
11	Maximum utility charging current Note: If setting value in program 02 is smaller than that in program in 11, the inverter will apply charging current from program 02 for utility charger.	2A 11 2A	10A 11 10A
		20A 11 20A	30A (default) 11 30A
		40A 11 40A	50A 11 50A
		60A 11 60A	

12	Setting voltage point back to utility source when selecting "SBU priority"	Available options in 3.2KVA 24V model:	
		22.0V 12 ^{BATT} 22.0 v ⊗	22.5V 12 ^{BATT} 22.5 v ⊗
		23.0V (default) 12 ^{BATT} 23.0 v ⊗	23.5V 12 ^{BATT} 23.5 v ⊗
		24.0V 12 ^{BATT} 24.0 v ⊗	24.5V 12 ^{BATT} 24.5 v ⊗
		25.0V 12 ^{BATT} 25.0 v ⊗	25.5V 12 ^{BATT} 25.5 v ⊗
		Available options in 2.2KVA 12V model:	
		11.0V 12 ^{BATT} 11.0 v ⊗	11.3V 12 ^{BATT} 11.3 v ⊗
		11.5V (default) 12 ^{BATT} 11.5 v ⊗	11.8V 12 ^{BATT} 11.8 v ⊗
		12.0V 12 ^{BATT} 12.0 v ⊗	12.3V 12 ^{BATT} 12.3 v ⊗
		12.5V 12 ^{BATT} 12.5 v ⊗	12.8V 12 ^{BATT} 12.8 v ⊗

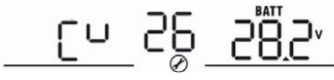
13	Setting voltage point back to battery mode when selecting "SBU priority"	Available options in 3.2KVA 24V model:	
		Battery fully charged	24V
			
		24.5V	25V
			
		25.5V	26V
			
		26.5V	27V (default)
			
		27.5V	28V
			
		28.5V	29V
			
		Available options in 2.2KVA 12V model:	
Battery fully charged	12.0V		
			
12.3V	12.5V		
			
12.8V	13.0V		
			
13.3V	13.5V (default)		
			
13.8V	14.0V		
			
14.3V	14.5V		
			

16	Charger source priority: To configure charger source priority	If this inverter/charger is working in Line, Standby or Fault mode, charger source can be programmed as below:	
		Solar first 16 C50	Solar energy will charge battery as first priority. Utility will charge battery only when solar energy is not available.
		Solar and Utility (default) 16 5NU	Solar energy and utility will charge battery at the same time.
		Only Solar 16 050	Solar energy will be the only charger source no matter utility is available or not.
		If this inverter/charger is working in Battery mode or Power saving mode, only solar energy can charge battery. Solar energy will charge battery if it's available and sufficient.	
18	Alarm control	Alarm on (default) 18 60N	Alarm off 18 60F
19	Auto return to default display screen	Return to default display screen (default) 19 ESP	If selected, no matter how users switch display screen, it will automatically return to default display screen (Input voltage /output voltage) after no button is pressed for 1 minute.
		Stay at latest screen 19 FEP	If selected, the display screen will stay at latest screen user finally switches.
20	Backlight control	Backlight on (default) 20 LON	Backlight off 20 LOF
22	Beeps while primary source is interrupted	Alarm on (default) 22 AON	Alarm off 22 AOF
23	Overload bypass: When enabled, the unit will transfer to line mode if overload occurs in battery mode.	Bypass disable (default) 23 byd	Bypass enable 23 byE
25	Record Fault code	Record enable 25 FEN	Record disable (default) 25 FdS

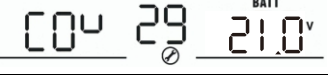
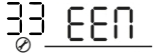
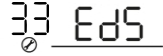
26	Bulk charging voltage (C.V voltage)	2.2KVA 12V default setting: 14.1V 	
		3.2KVA 24V default setting: 28.2V 	
		If self-defined is selected in program 5, this program can be set up. Setting range is from 12.5V to 14.6 V for 2.2KVA 12V model and 25.0V to 29.2 V for 3.2KVA 24V model. Increment of each click is 0.1V.	
27	Floating charging voltage	2.2KVA 12V default setting: 13.5V 	
		3.2KVA 24V default setting: 27.0V 	
		If self-defined is selected in program 5, this program can be set up. Setting range is from 12.5V to 14.6V for 2.2KVA 12V model and 25.0V to 29.2 V for 3.2KVA 24V model. Increment of each click is 0.1V.	
29	Low DC cut-off voltage	2.2KVA 12V default setting: 10.5V 	
		3.2KVA 24V default setting: 21.0V 	
		If self-defined is selected in program 5, this program can be set up. Setting range is from 10.0V to 12.0V for 2.2KVA 12V model and 20.0V to 24.0V for 3.2KVA 24V model. Increment of each click is 0.1V. Low DC cut-off voltage will be fixed to setting value no matter what percentage of load is connected.	
33	Battery equalization		
		If "Flooded" or "User-Defined" is selected in program 05, this program can be set up.	

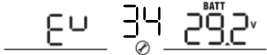
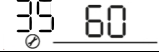
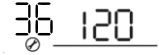
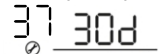
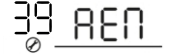
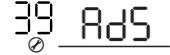
34	Battery equalization voltage	2.2KVA default settig :14.6V 	
		Setting range is from 12.5V to 15 V. Increment of each click is 0.1V.	
		3.2KVA default setting: 29.2V 	
		Setting range is from 25.0V to 29.5V. Increment of each click is 0.1V.	
35	Battery equalized time	60min (default) 	Setting range is from 5min to 900min. Increment of each click is 5min.
36	Battery equalized timeout	120min (default) 	Setting range is from 5min to 900 min. Increment of each click is 5 min.
37	Equalization interval	30days (default) 	Setting range is from 0 to 90 days. Increment of each click is 1 day
39	Equalization activated immediately	Enable 	Disable (default) 
		If equalization function is enabled in program 33, this program can be set up. If "Enable" is selected in this program, it's to activate battery equalization immediately and LCD main page will shows "E9". If "Disable" is selected, it will cancel equalization function until next activated equalization time arrives based on program 37 setting. At this time, "E9" will not be shown in LCD main page.	

5.5 DisplaySetting

The LCD display information will be switched in turns by pressing “UP” or “DOWN” key. The selectable information is switched as below order: input voltage, input frequency, PV voltage, charging current, PV power, battery voltage, output voltage, output frequency, load percentage, load in Watt, load in VA, DC discharging current, CPU Version.



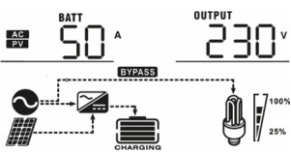
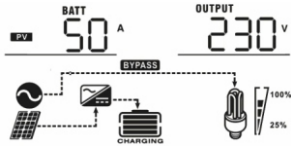
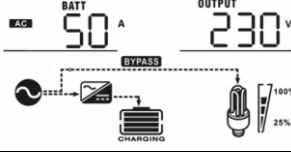
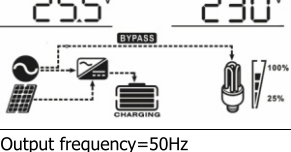
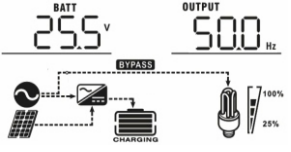
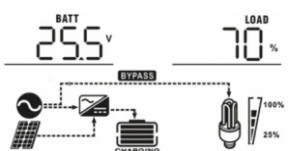

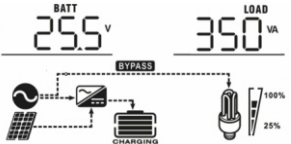
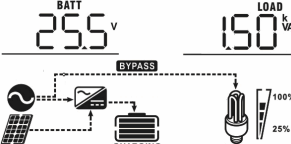
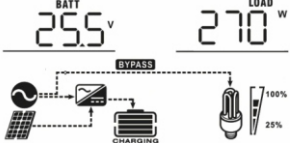
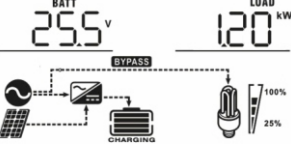

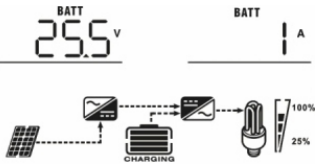
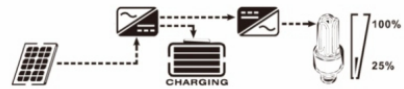

Selectable information	LCD display
Input voltage/Output voltage (Default Display Screen)	<p>Input Voltage=230V, output voltage=230V</p>
Input frequency	<p>Input frequency=50Hz</p>
PV voltage	<p>PV voltage=260V</p>
PV power	<p>PV power = 500W</p>

<p>Charging current</p>	<p>AC and PV charging current=50A</p>  <p>PV charging current=50A</p>  <p>AC charging current=50A</p> 
<p>Battery voltage and output voltage</p>	<p>Battery voltage=25.5V, output voltage=230V</p> 
<p>Output frequency</p>	<p>Output frequency=50Hz</p> 
<p>Load percentage</p>	<p>Load percent=70%</p> 

<p>Load in VA</p>	<p>When connected load is lower than 1kVA, load in VA will present xxxVA like below chart.</p>  <p>When load is larger than 1kVA ($\geq 1\text{kVA}$), load in VA will present x.xkVA like below chart.</p> 
<p>Load in Watt</p>	<p>When load is lower than 1kW, load in W will present xxxW like below chart.</p>  <p>When load is larger than 1kW ($\geq 1\text{kW}$), load in W will present x.xkW like below chart.</p> 

<p>Battery voltage/DC discharging current</p>	<p>Battery voltage=25.5V, discharging current=1A</p> 
<p>CPU version checking</p>	<p>CPU version 20 11</p> 

5.6 Operating Mode Description

Operation mode	Description	LCD display
<p>Standby mode / Power saving mode</p> <p>Note:</p> <p>*Standby mode: The inverter is not turned on yet but at this time, the inverter can charge battery without AC output.</p> <p>*Power saving mode: If enabled, the output of inverter will be off when connected load is pretty low or not detected.</p>	<p>No output is supplied by the unit but it still can charge batteries.</p>	<p>Charging by utility and PV energy.</p>  <p>Charging by utility.</p>  <p>Charging by PV energy.</p>  <p>No charging.</p> 
<p>Fault mode</p> <p>Note:</p> <p>*Fault mode: Errors are caused by inside circuit error or external reasons such as over temperature, output short circuited and so on.</p>	<p>PV energy and utility can charge batteries.</p>	<p>Charging by utility and PV energy.</p>  <p>Charging by utility.</p>  <p>Charging by PV energy.</p>  <p>No charging.</p> 

Operation mode	Description	LCD display
Line Mode	The unit will provide output power from the mains. It will also charge the battery at line mode.	Charging by utility and PV energy.
		Charging by utility.
		If "SUB priority" is selected as output source priority and solar energy is not sufficient to provide the load, solar energy and the utility will provide the loads and charge the battery at the same time.
Battery Mode	The unit will provide output power from battery and PV power.	Power from battery and PV energy.
		PV energy will supply power to the loads and charge battery at the same time.
		Power from battery only.

5.7 Battery Equalization Description

Equalization function is added into charge controller. It reverses the buildup of negative chemical effects like stratification, a condition where acid concentration is greater at the bottom of the battery than at the top. Equalization also helps to remove sulfate crystals that might have built up on the plates. If left unchecked, this condition, called sulfation, will reduce the overall capacity of the battery. Therefore, it's recommended to equalize battery periodically.

• How to Apply Equalization Function

You must enable battery equalization function in monitoring LCD setting program 33 first. Then, you may apply this function in device by either one of following methods:

1. Check the program 5 is user-defined or flooded mode .
2. Check program 33 is enabled.
3. Setting equalization in the program 34 to program 37 , that is depend on your battery requirements . (detailed information in LCD Setting part) .
4. Active equalization immediately in program 39.

- **When to Equalize**

In float stage, when the setting equalization interval (battery equalization cycle) is arrived, or equalization is active immediately, the controller will start to enter Equalize stage.

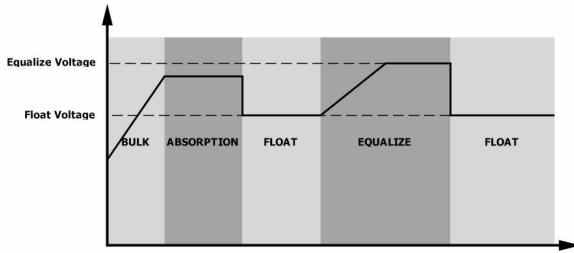

- **Equalize charging time and timeout**



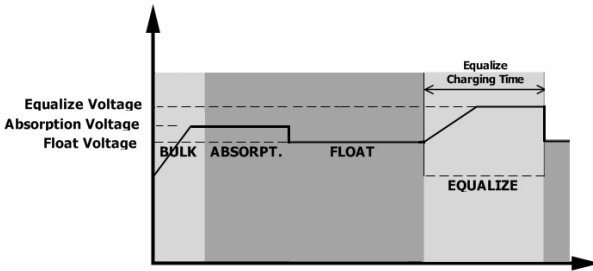



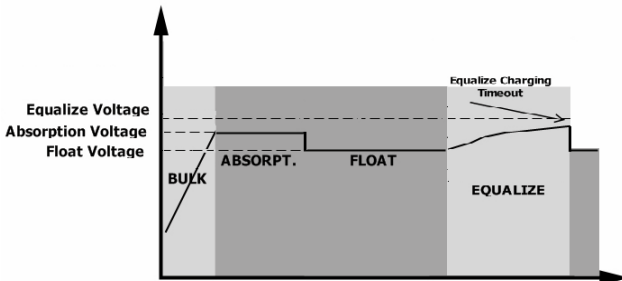









In Equalize stage, the controller will supply power to charge battery as much as possible until battery voltage raises to battery equalization voltage. Then, constant-voltage regulation is applied to maintain battery voltage at the battery equalization voltage. The battery will remain in the Equalize stage until setting battery equalized time is arrived.







However, in Equalize stage, when battery equalized time is expired and battery voltage doesn't rise to battery equalization voltage point, the charge controller will extend the battery equalized time until battery voltage achieves battery equalization voltage. If battery voltage is still lower than battery equalization voltage when battery equalized timeout setting is over, the charge controller will stop equalization and return to float stage.



5.8 Fault Reference Code

Fault Code	Fault Event	Icon on
01	Fan is locked when inverter is off	
02	Over temperature	
03	Battery voltage is too high	
04	Battery voltage is too low	
05	Output short circuited or over temperature is detected by internal converter components	
06	Output voltage is too high	
07	Overload time out	
08	Bus voltage is too high	
09	Bus soft start failed	
11	Main relay failed	
13	Solar charger stops due to high PV voltage	
51	Over current or surge	
52	Bus voltage is too low	
53	Inverter soft start failed	
55	Over DC voltage in AC output	
57	Current sensor failed	
58	Output voltage is too low	

5.9 Warning Indicator

Warning Code	Warning Event	Audible Alarm	Icon flashing
01	Fan is locked when inverter is on.	Beep three times every second	
03	Battery is over-charged	Beep once every second	
04	Low battery	Beep once every second	
07	Overload	Beep once every 0.5 second	
10	Output power derating	Beep twice every 3 seconds	

6 CLEARANCE AND MAINTENANCE FOR ANTI -DUST KIT (Optional)

6.1 Overview

Every inverter is already installed with anti-dusk kit from factory. Inverter will automatically detect this kit and activate internal thermal sensor to adjust internal temperature. This kit also keeps dusk from your inverter and increases product reliability in harsh environment.

6.2 Clearance and Maintenance(option)

Step 1: Please remove screws as below.

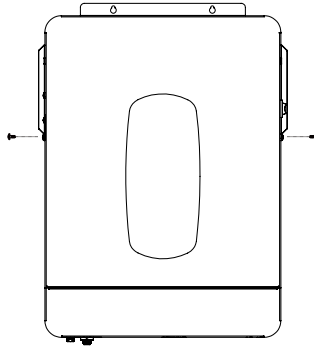

Step 2: Then, dustproof case can be removed and take out air filter foam as shown in below chart.

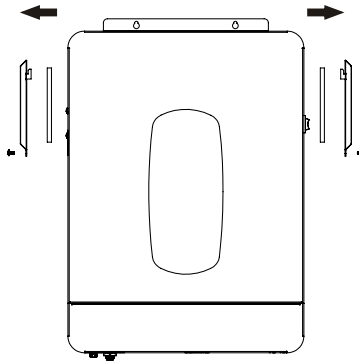

Step 3: Clean air filter foam and dustproof case. After clearance, re-assemble the dust-kit back to the inverter.

NOTICE: The anti-dust kit should be cleaned from dust every one month.

7. INSTRUCTIONS FOR HOW TO ENTER THE DISPLAY INTERFACE FOR LITHIUM BATTERY AND TURN THE INTERFACE

1. Long press ENTER key to enter the setting item and set the 05 item to lithium battery mode Lib (as shown in the figure below).



2. Long press the ESC key to enter the lithium battery display interface (as shown in the picture below)

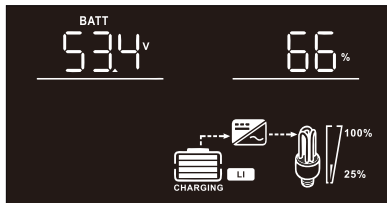







The initial display interface indicate the total battery voltage and remaining battery capacity

Press the DOWN key to indicate the data as below in turn

LCD data on the left	LCD data on the right	instruction
Total battery voltage	Remaining battery capacity	
Battery charging current	Battery discharge current	
Battery capacity	Battery charge/discharge times	Warning in the middle
BMS board temperature	Mosfet temperature of BMS board	
Maximum voltage of a single battery	Minimum voltage of a single battery	
Maximum temperature of a single battery	Minimum temperature of a single battery	

3.Detailed description of display interface for lithium battery

<p>Total battery voltage; Battery residual capacity (Initial interface display)</p>	<p>Total battery voltage=50.5V Battery residual capacity=4%</p> 
<p>Battery charging current; Battery discharge current</p>	<p>Battery charging current= 0A Battery discharge current=21A</p> 
<p>Battery capacity; Battery charger/discharge Times</p>	<p>Battery capacity=100Ah Battery charger/discharge Times=4</p> 
<p>BMS board temperature; MOSFET temperature of BMS board</p>	<p>Battery ambient temperature=25.9°C Battery MOS temperature=25.7°C</p> 
<p>Maximum voltage of a single battery; Minimum voltage of a single battery</p>	<p>Maximum voltage of a single battery=3.20V Minimum voltage of a single battery=3.10V</p> 
<p>Maximum temperature of a single battery; Minimum temperature of a single battery</p>	<p>Maximum temperature of a single battery=25.0°C Minimum temperature of a single battery=24.2°C</p> 

4.Warning Code

Warning Code	Warning Event	Warning Event
21	Battery Cell Over Voltage	21 [△]
22	Battery Cell Low Voltage	22 [△]
23	Battery Pack Over Voltage	23 [△]
24	Battery Pack Low Voltage	24 [△]
25	Charging Over Current	25 [△]
26	Discharging Over Current	26 [△]
27	Charging Cell High Temperature	27 [△]
28	Discharging Cell High Temperature	28 [△]
29	Charging Cell Low Temperature	29 [△]
30	Discharging Cell Low Temperature	30 [△]
31	Environment High Temperature	31 [△]
32	Environment Low Temperature	32 [△]
33	MOSFET High Temperature	33 [△]

5.Falut Code

Falut Code	Warning Event	Warning Event
21	Battery Cell Over Voltage	21 _{err}
22	Battery Cell Low Voltage	22 _{err}
23	Battery Pack Over Voltage	23 _{err}
24	Battery Pack Low Voltage	24 _{err}
25	Charging Over Current	25 _{err}
26	Discharging Over Current	26 _{err}
27	Charging Cell High Temperature	27 _{err}
28	Discharging Cell High Temperature	28 _{err}
29	Charging Cell Low Temperature	29 _{err}
30	Discharging Cell Low Temperature	30 _{err}
31	Environment High Temperature	31 _{err}
32	Environment Low Temperature	32 _{err}
33	MOSFET High Temperature	33 _{err}
35	Short Circuit	35 _{err}
36	Charger Over Voltage	36 _{err}

8 SPECIFICATIONS

Table 1 Line Mode Specifications

INVERTER MODEL	2.2KVA-12V	3.2KVA-24V
Input Voltage Waveform	Sinusoidal (utility or generator)	
Nominal Input Voltage	230Vac	
Low Loss Voltage	170Vac±7V (UPS); 90Vac±7V (Appliances)	
Low Loss Return Voltage	180Vac±7V (UPS); 100Vac±7V (Appliances)	
High Loss Voltage	280Vac±7V	
High Loss Return Voltage	270Vac±7V	
Max AC Input Voltage	300Vac	
Nominal Input Frequency	50Hz / 60Hz (Auto detection)	
Low Loss Frequency	40±1Hz	
Low Loss Return Frequency	42±1Hz	
High Loss Frequency	65±1Hz	
High Loss Return Frequency	63±1Hz	
Output Short Circuit Protection	Circuit Breaker	
Efficiency (Line Mode)	>95% (Rated R load, battery full charged)	
Transfer Time	10ms typical (UPS); 20ms typical (Appliances)	
<p>Output power derating: When AC input voltage drops to 170V, the output power will be derated.</p>	 <p>The graph illustrates the output power derating characteristics. The vertical axis represents Output Power, and the horizontal axis represents Input Voltage. Key points on the graph include: <ul style="list-style-type: none"> At 90V input, the output power is 50% of the rated power. Between 90V and 170V, the output power increases linearly from 50% to the full Rated Power. At 170V, the output power reaches the Rated Power level. From 170V to 280V, the output power remains constant at the Rated Power level. At 280V, the output power drops to zero. </p>	

Table 2 Inverter Mode Specifications

INVERTER MODEL	2.2KVA-12V	3.2KVA-24V
Rated Output Power	2200VA/1800W	3200VA/3000W
Output Voltage Waveform	Pure Sine Wave	
Output Voltage Regulation	230Vac \pm 5%	
Output Frequency	50Hz	
Peak Efficiency	94%	
Overload Protection	5s@ \geq 150% lo ad; 10s@ 110% ~ 150% lo ad	
Surge Capacity	2* rated power for 5 seconds	
Nominal DC Input Voltage	12Vdc	24Vdc
Cold Start Voltage	11.5Vdc	23.0Vdc
Low DC Warning Voltage		
@ lo ad < 50%	11.0Vdc	22.0Vdc
@ load \geq 50%	10.5Vdc	21.0Vdc
Low DC Warning Return Voltage		
@ load < 50%	11.5Vdc	22.5Vdc
@ load \geq 50%	11.0Vdc	22.0Vdc
Low DC Cut-off Voltage		
@ load < 50%	10.2Vdc	20.5Vdc
@ load \geq 50%	9.6Vdc	20.0Vdc
High DC Recovery Voltage	14.5Vdc	29Vdc
High DC Cut-off Voltage	15.5Vdc	31Vdc
No Load Power Consumption	<25W	<35W

Table 3 Charge Mode Specifications

Utility Charging Mode		
INVERTER MODEL	2.2 KVA-12V	3.2KVA-24V
Charging Algorithm		3-Step
AC Charging Current (Max)		60Amp (@ $V_{LP}=230Vac$)
Bulk Charging Voltage	Flooded Battery	14.6
	AGM / Gel Battery	14.1
Floating Charging Voltage		13.5Vdc
Charging Curve		
MPPT Solar Charging Mode		
INVERTER MODEL	2.2KVA-12V	3.2KVA-24V
Max. PV Array Power	2000W	3000W
Nominal PV Voltage	240Vdc	
PV Array MPPT Voltage Range	55~430Vdc	
Max. PV Array Open Circuit Voltage	450Vdc	
Max Charging Current (AC charger plus solar charger)	80Amp	

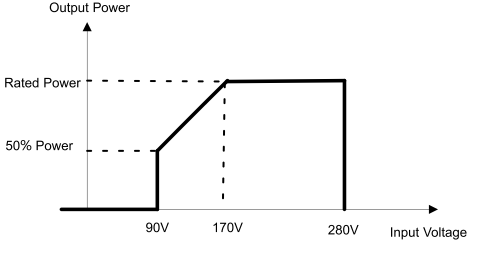
Table 4 General Specifications

INVERTER MODEL	2.2KVA-12V	3.2KVA-24V
Safety Certification	CE	
Operating Temperature Range	-10 °C to 50 °C	
Storage temperature	-15 °C~ 60 °C	
Humidity	5% to 95% Relative Humidity (Non-condensing)	
Dimension (D * W * H) , mm	348*282*105mm	
Net Weight, kg	5.0	5.5

9 TROUBLE SHOOTING

Problem	LCD/LED/Buzzer	Explanation / Possible cause	What to do
Unit shuts down automatically during startup process.	LCD/LEDs and buzzer will be active for 3 seconds and then complete off.	The battery voltage is too low (<1.91V/Cell)	1. Re-charge battery. 2. Replace battery.
No response after power on.	No indication.	1. The battery voltage is far too low. (<1.4V/Cell) 2. Internal fuse tripped.	1. Contact repair center for replacing the fuse. 2. Re-charge battery. 3. Replace battery.
Mains exist but the unit works in battery mode.	Input voltage is displayed as 0 on the LCD and green LED is flashing.	Input protector is tripped	Check if AC breaker is tripped and AC wiring is connected well.
	Green LED is flashing.	Insufficient quality of AC power. (Shore or Generator)	1. Check if AC wires are too thin and/or too long. 2. Check if generator (if applied) is working well or if input voltage range setting is correct. (UPS Appliance)
When the unit is turned on, internal relay is switched on and off repeatedly.	LCD display and LEDs are flashing	Battery is disconnected.	Check if battery wires are connected well.
Buzzer beeps continuously and red LED is on.	Fault code 07	Overload error. The inverter is overload 110% and time is up.	Reduce the connected load by switching off some equipment.
	Fault code 05	Output short circuited.	Check if wiring is connected well and remove abnormal load.
		Temperature of internal converter component is over 120°C.	Check whether the air flow of the unit is blocked or whether the ambient temperature is too high.
	Fault code 02	Internal temperature of inverter component is over 100°C.	
	Fault code 03	Battery is over-charged.	Return to repair center.
		The battery voltage is too high.	Check if spec and quantity of batteries are meet requirements.
	Fault code 01	Fan fault	Replace the fan.
	Fault code 06/58	Output abnormal (Inverter voltage below than 190Vac or is higher than 260Vac)	1. Reduce the connected load. 2. Return to repair center
	Fault code 08/09/53/57	Internal components failed.	Return to repair center.
	Fault code 51	Over current or surge.	Restart the unit, if the error happens again, please return to repair center.
Fault code 52	Bus voltage is too low.		
Fault code 55	Output voltage is unbalanced.		

技术要求： 单页尺寸142*210mm；
材质：封面105g铜版纸,内页80g书写纸；
料号打于后封面左下角；
颜色：黑白印刷
注：此技术要求不用印刷